



WILGER SPRAYER & LIQUID FERTILIZER PARTS CATALOG

REVISED DECEMBER 2021

WORLD CLASS SPRAYING COMPONENTS

Spray Tips



COMBO-JET
Drift Reduction

Tip Wizard



TIP WIZARD
Spray Tip
Selection Tool

Sprayer Parts



**Nozzle Bodies
& Plumbing Parts**

Flow Indicators



**Visual Detection
of Plugged Lines**

FOR MORE
INFORMATION
VISIT

WWW.WILGER.NET

Flow Monitoring



**Row-by-Row
Flowmeter**



©Copyright 2022 Wilger Industries Ltd.
All rights reserved.

UNITS: US GALLON/ACRE

New Products3-4

Double-Down & Agrifac Outlet Adapters	3
2" & 5" Nozzle Outlet Extension Caps	3
COMBO-RATE II Top Turrets w/ Double-Down	3
Quick-Flange Sprayer Boom Fittings	3
New Wilger 3-hole Fertilizer Streamer Nozzles	4
O-ring Seal to Square Lug Outlet	4
O-ring Seal Strainer Check Valves, Strainers & More	4

Spraying Resources & Topics5-9

Combo-Jet Spray Nozzle Advantage & FAQ	5
Differences between ER/SR/MR/DR/UR series	5
Spray Quality, VMD & Droplet Size	6
Double-Down & Multi-Angle Spraying - When & Why?	6
How to Use Tip Wizard - First Time Users	7
Spray Tip Selection Guide for:	
Standard (Auto-Rate) Spray Systems	7
Pulse Width Modulation (PWM) Spray Systems	8
Double Nozzle (Double-Down or Multi-Angle) Spraying	9
Reducing 'Nozzle run-on' with top-fed bodies	33
Increasing Coverage with Crop-Adapted Spraying	37,39

Spray Nozzles & Metering10-30

ER Series Overview, 80° & 110°	10
SR Series Overview, 80° & 110°	11
MR Series Overview, 80° & 110°	12
DR Series Overview, 80° & 110°	13
UR Series Overview, 110°	14
80° Nozzle Charts	15-17
110° Nozzle Charts	18-20
80° Nozzle Charts for PWM (Common Solenoid)	21-23
110° Nozzle Charts PWM (Common Solenoid)	24-25
Narrow Angle for Narrow & Spot Spraying	
- ER Series Spray Nozzles, 20°, 40° & 60°	26
- DX Series Spray Nozzles, 20°, 40° & 60°	26
LERAP (UK) Nozzle Ratings	26
Flanged ER 80/110 Spray tips	27
Nozzle Adapters & Strainers	27
Slotted Nozzle Caps (for using insert-able tips)	27
Plug & Threaded Outlet Caps	28
Hose Barb Caps	28
Quick-Connect (Push-in-tube) Caps	28
Hose Drop & Extension Caps, Fittings	28
Fertilizer Streamer Caps	28-30
COMBO-JET Metering Orifices	29-30

Wet Boom Nozzle Bodies31-37

Combo-Jet Swivel Bodies (1-3 Outlets)	31
KWIKSTOP™ Raised Inlet Nozzle Bodies	31-32
Square Lug Swivel Bodies (1-3 Outlets)	32
Square Lug Caps, Strainers	32
Combo-Rate Nozzle Body Components & Accessories ...	33-37
Combo-Rate Side-Fed Inlet Saddles	33
Combo-Rate II One-Way Saddles (Top/Bottom Fed)	33
Combo-Rate II Two-Way Saddles (Top/Bottom Fed)	33
Combo-Rate II Stacking Nozzle Bodies	34
Combo-Rate Turret Replacement Parts	34
Combo-Rate Stacking Thru, End, and Swivel Bodies	35
Combo-Rate Front, Side, & Top Turrets (3-5 Outlets)	35-36
Combo-Rate Double-Down Turrets	35-36
Multi-Angle & Double-Down Spraying - Examples	37

Dry Boom Nozzle Bodies38-41

Compact Nozzle Bodies	38
Swivel turret adapters (2-3 Outlets)	38
Square-Mount Nozzle Bodies	38
High-Mount Nozzle Bodies	38
Low-Mount Compact Nozzle Bodies	39
Adjustable Swivel Bodies	39
Clamps for Sprayer Booms & 1/4" Bolt Mount Parts	40
Boomless Sprayer Nozzle Bodies & Assemblies	40
Estate Sprayer Manifold Parts & Assemblies	41

Sprayer Plumbing42-47

Sprayer Boom Clamps	40
COMBO-RATE Control Manifolds & Components	41
1" Wilger Stainless Steel Tube (1.315" OD)	42
1/2" Wilger Stainless Steel Tube (0.84" OD)	42
1" Quick-Flange Fitting System (QF100)	43-45
Boom Hygiene & Boom End Flush Valves	43-44,46
1" Quick Nut Fitting System (QN100)	46
1/2" Quick Nut Fitting System (QN50)	47
Case TWS Boom System Fittings	47
Recirculating Sprayer Booms	47

Liquid Fertilizer Parts48-50

O-ring Seal Inlets & Outlets	48
O-ring Seal End Caps	48
O-ring Seal Check Valves	48
O-ring Seal Tees, Elbows & Plumbing Fittings	49
O-ring Seal Stackable Manifolds (1-4 Outlets)	49
O-ring Seal Metering Orifices	49-50
Replacement Parts & Mounting Clamps	50

Liquid Fertilizer Monitoring51-55

FLOW VIEW Visual Ball Flow Indicators	51
Benefits of Liquid Fertilizer Blockage	51
Required Column Storage & Telling Columns Apart	51
How to Build a Liquid Kit	52
Liquid Monitoring for Dark Liquids & Low Visibility	52
Which Flow Indicator Ball To Use	52
Wilger Electronic Flow Monitoring System & Parts	53-55

For Terms and Conditions, visit www.wilger.net

Wilger products are sold exclusively to original equipment manufacturers and authorized distributors, and are available to the end user through their retail dealerships.

Warranties - Wilger warrants that its products are free of defects in material and workmanship and perform to each product's specifications. The foregoing warranties are in lieu of all other warranties, written or expressed, including, but not limited to, those concerning suitability for a particular purpose. Claims under these warranties must be made promptly within one (1) year after receipt of goods by the buyer. Any warranty action by the buyer must be expressly pre-authorized by Wilger.

Technical Assistance - Wilger personnel are available to provide technical assistance in the choice and use of products furnished to the buyer and will do so free of charge. Wilger assumes no obligation or liability for any such advice, or any consequences occurring as a result of the application of such advice. The buyer is solely responsible for the selection of the appropriate product(s) and the appropriate application to the intended end use.

Limitation of Liabilities - Except for claims for bodily injury, Wilger's liability for any and all claims arising out of the purchase of the product shall not exceed the billed or billable value of the product. In no case will Wilger be liable for any consequential damages or loss of profit, even if Wilger has been advised of the possibility of such damages.

FEATURED & NEW SPRAYER PARTS FOR 2022

NEW PARTS

New COMBO-JET® Double-Down & Agrifac Adapters



40441-00
Double-Down Adapter
sprays two nozzles
straight down

PWM
APPROVED



40206-00
SO LUG
To Double-Down
-TWISTLOCK-

PWM
APPROVED

Converts a square lug outlet to double-down COMBO-JET outlets

New options for Double-Down Spraying!

Ideal for high-volume applications, tough to reach targets, and making the most out of the nozzles you have on hand.



40205-00
AGRIFAC
To CJ
-sleeve-

PWM
APPROVED

The simple adapter sleeve snaps into any COMBO-JET cap to convert to Agrifac outlet

COMBO-RATE® Top Turrets

A top take-off turret is even more compact for larger PWM solenoids. Available with **double-down spray** options, with backwards compatibility with all COMBO-RATE parts.



41836-00
No Nut
(for PWM)
with Double-down

PWM
APPROVED

2" & 5" Outlet Extensions

For extending nozzles down 2" ⁵/₈" to avoid boom frame interference for angled spray nozzles & more.



40210-00
2" Combo-Jet Cap
Extension

2.25"

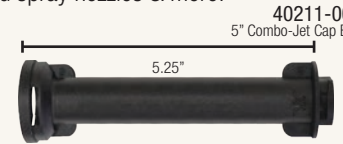

40211-00
5" Combo-Jet Cap
Extension

5.25"

COMBO-RATE® Swivel End Body

A new COMBO-RATE end body that provides a swivel joint that is **adjustable in 15° increments**, and locked into place for crop adapted spraying or fence-row nozzle spraying.



Reversible &
Adjustable in
15° Increments

COMBO-RATE® Boom End Flush Valve

A new 'last nozzle body' that is integrated directly into a flush valve for a super compact boom end nozzle & flush valve.



Perfect
Recirc.
Booms



Remove
Deadspots
for Boom
Hygiene



Stronger
Compact
Fittings

Quick Flange Sprayer Boom Fittings

The sprayer boom fittings for the next generation of sprayers

- Heavy-duty boom fittings that open up plumbing possibilities
- Ultimate configurations available for recirculating sprayer booms
- Common compatibility with common 1" flange fittings & more
- Even more fittings released into 2022

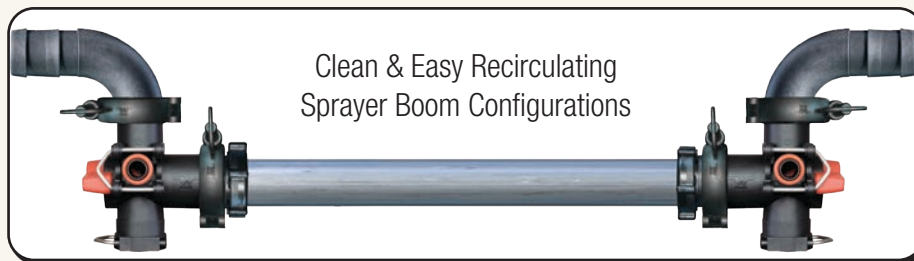

Clean & Easy Recirculating
Sprayer Boom Configurations



Compact Flush
& Recirc
NEW



Easy Flange
Boom End
Conversion for
Case TWS

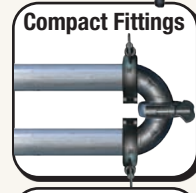

Compact Fittings



Easy Flange
Boom End
Conversion for
QN SST



No More
Threaded Fittings



Easy Flange
Boom End
Conversion for
1" Pipe

New COMBO-RATE Pre-Assembled Manifolds for estate, yard & ATV sprayers

Need to replace your yard sprayer's control manifold?
Building your own yard or ATV sprayer?

COMBO-RATE manifolds are modular and can be expanded or modified with any COMBO-RATE fittings. From pressure regulators, pressure gauges, to anything else that might be required.



41115-03
(w/o barbs & gauge)

Combo-Rate® 3-Outlet Control Manifold



41115-02
(w/o barbs & gauge)

Example Sprayer Manifold
for Booms & Wand

COMBO-JET® Nozzle Bodies for PWM

Are you retrofitting your sprayer to PWM?

Cost-effective & compact nozzle body for any tight sprayer boom.



40623-NM
1" Combo-Jet Triple Swivel
Nozzle Body



40663-NM
1" Square Lug
Triple Swivel Nozzle Body

High-Flow COMBO-RATE II Bodies

21/32" inlet nozzle bodies can provide 45% more flow for flow rates upwards of 60 US GPA @ 15MPH with a single outlet.

Check the COMBO-RATE section.



PWM
APPROVED

NEW LIQUID FERTILIZER PARTS FOR 2022



NEW 3-Hole Fertilizer Streamer Nozzles

Precision molded & color-coded liquid fertilizer streamer caps for consistent liquid fertilizer with less plant burn. Available in molded sizes from 0.15-2.0 us gpm.

Includes metering orifice and deflector plate in a single part number for easy ordering.

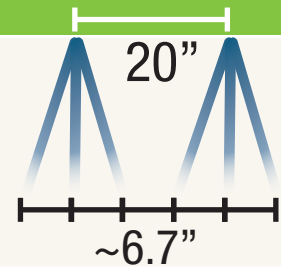

New O-Ring Seal Fittings & Assemblies

ORS Straight Check Valves
10 PSI
Manual ON/OFF
Check Valve,
Straight
20556-00



ORS Inline Strainer
attaches to any ORS
fitting
20576-00
Strainer Assembly

20576-02
50 Mesh
Replacement
Strainer

1" ORS Hose Barbs



20515-00
1" Hosebarb, 90°

20504-V0
1" HB Straight
Viton

ORS to Square Lug
Outlet for Liquid
Fertilizer Kits
20549-00



20644-00
4 Outlet EFM Manifold with new
Straight 10 PSI
Manual ON/OFF Check Valves



New pre-assembled Flowmeter Manifolds

New electronic flowmeter manifolds with straight check valve allow for easy ordering and building of systems.

Simply replicate each section of the implement with manifolds of the same size, cap off the ends, add a hose feed, and away you go.

Available in manifolds of 1-4 Outlets.

Wilger Electronic Row-By-Row Flow Monitoring System

The serviceable flowmeter designed & built specifically for agricultural chemical & liquid applications



Simply enough, one of the highest compliments you can give farm equipment is "It works."

No fuss, no muss, it does the job it is supposed to do.

We are proud that for years, applicators have had exactly that (and more) to say about the EFM system.

The system worked after set up and typically ends up helping troubleshoot other equipment issues unrelated to the EFM, saving unexpected downtime & costs.

With a customize-able app and interface based on user input, it will quickly pay itself off in value for the farm.

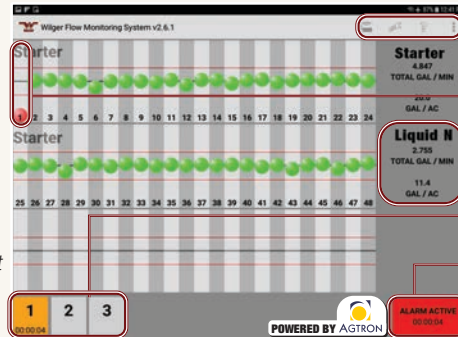

Simple menu and tools for setting up & customizing screens

Yellow & Red balls & lines show custom alarm% thresholds.

Up to 3 different products can be monitored on one EFM system at the same time.

Two Simplified Views:

Single Product View -

3 screens showing up to 72 rows

Multi-Product View:

10 sections up to 24 rows /section

Mutable Alarm button is able to alarm even if app is operating in the background



Fittings Swivel 360°



Crystal Clear Flowmeter



Superior Chemical Resistance



Serviceable Flowmeter for Ag.



High Accuracy Flowmeter



Acid Resistant Parts



EFM systems are developed by OEM manufacturers using WILGER parts

Wilger Product Literature & Tools



Wilger provides free printed product literature, prices lists and tools. Request a copy today. All brochures are also available at www.wilger.net

FREE Tip Wizard Updates



Tip Wizard has new features! ORS metering orifice calculator, Flow Indicator Ball Selector, and further improved Tip Wizard spray tip search.

Tip Wizard aims to lead the industry as the best spray tip calculator for broadcast applications.

WHERE TO BUY WILGER PRODUCT

To find a list of local dealers/retailers and distributors in your area, visit the [WILGER.net](http://www.wilger.net) 'WHERE TO BUY' page, to easily enter your address to find local Wilger product.

The COMBO-JET® Spray Tip Advantage

- Less plugging, as the path of flow always gets larger
- 40% longer strainer that snaps & seals into place
- SR / MR / DR / UR
50% 75% 90% 90%+
Drift Reduction Series
- Cap color matched to flow rate
- Super long-lasting stainless steel spray tip
- The most versatile spray tips for Pulse Width Modulation Systems (e.g. Capstan Pinpoint®, EVO®, Case AIM Command®, John Deere ExactApply®, IntelliSpray®, Raven Hawkeye®, & more)
- Spray tip & cap are held together as one piece
- Easy-to-read label
(MR110-06 = IMR Series, 110° tip, 0.6 US GPM flow rate)
- Best educational spray tip charts & tools provided to select the best spray tips
- Combo-Jet tips use a modern pre-orifice & closed chamber design that produces significantly less drift, creating solid mass droplets, for maximum spray velocity and more meaningful spray.

Without needing consistent air induction for drift reduction, Combo-Jet spray tips are the preferred tip for Pulse Width Modulation (PWM) spraying systems.
*Capstan EVO®, Capstan Pinpoint®, Case AIM Command®, John Deere ExactApply®, IntelliSpray®, Raven Hawkeye® are not affiliated or owned by Wilger. They remain property of their respective owner(s).

WILGER.NET has the most useful spray tip selection help in the world.

- FREE TIP WIZARD** SMARTPHONE APP
- TIP WIZARD ONLINE
- EXCEL-BASED CHARTS
- PRINTED TIP CHARTS
- WILGER CATALOG

COMBO-JET® ER/SR/MR/DR/UR Spray Tips - What is the difference?

The sliding scale of droplet size means at any flow rate, you can match your desired spray quality.

5 Series of Spray Tips for a Sliding Scale of Droplet Size

FINER SPRAY (ER110-06) → SR110-06 → MR110-06 → DR110-06 → BEST DRIFT REDUCTION (UR110-06)

U.S. Patent No. 10,603,681

Comparison Criteria	ER Series Extended Range	SR Series Small Reduction	MR Series Mid-Range Reduction	DR Series Drift Reduction	UR Series Drift Reduction
Spray Tip Design	Conventional Flat Fan	Pre-orifice Drift Reduction	Pre-orifice Drift Reduction	Pre-orifice Drift Reduction	Dual Chamber Drift Red.
Spray Quality @40PSI	Medium	Coarse	Extremely Coarse	Extremely Coarse	Ultra-Coarse
Droplet Size ¹ @40PSI	Smallest (246µ VMD ¹)	Medium (371µ VMD ¹)	Large (474µ VMD ¹)	Very Large (529µ VMD ¹)	Ultra Coarse (633µ VMD ¹)
% <141µ ² % <600µ ³	20% of volume < 141µ 94% of volume <600µ	8% of volume < 141µ 89% of volume <600µ	4% of volume < 141µ 74% of volume <600µ	2% of volume < 141µ 64% of volume <600µ	UR spray tips are specialty spray tips, designed for certain chemical applications that require exceptional drift reduction.
Drift Potential	Most likely to drift	Lower drift potential	Major reduction in drift	Very low drift potential	They are not to be replaced with other spray tip series that are not approved to be on the chemical label. Always follow up-to-date label information.
Coverage	Best	Excellent	Very good	Good	Refer to chemical application label for maximum pressures, speeds and application information.

¹Based on an XX110-06 nozzle @ 40 psi (2.75 BAR)

²Droplets smaller than 141µ are more likely to drift. 141µ is used as a standard for estimating driftable fines.

³Droplets smaller than 600µ provide better coverage. Droplets > 600µ consume more spray volume, reducing overall coverage.

More information available at www.wilger.net

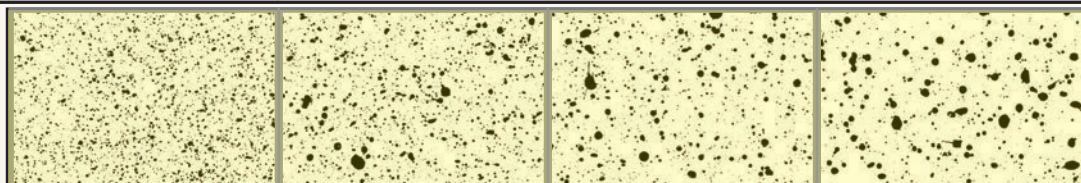

Selecting the Right Spray Quality & Droplet Size

Drift vs. Efficacy

Generally speaking, smaller droplets deposit on the target more effectively than larger droplets, but larger droplets will drift less. So, when balancing drift control and efficacy, ensure to follow chemical labels and guidelines to designate the required spray quality and droplet size.

Where to find target spray quality or droplet size?

Depending on the chemical, as well as the different methods and modes of applications, some chemical labels may have less/more information. In general, chemical labels will have a description of how it should be applied, in the form of an ASABE spray classification recommendation, or a minimum spray classification (e.g. Spray at least ASABE Coarse). Some chemical label will also stipulate which nozzles can be used.

Application Information:
 • Water Volume: Minimum 22 L per acre. *Minimum volume requirement on chemical label*
 • Nozzles and Pressure: 30 to 40 psi (210 to 275 kPa) when using conventional flat fan nozzles. *Reference max pressure for conventional nozzles like ER series. Try avoid conventional (non-drift reduction) spray tips.*
 Low drift nozzles may require higher pressures for proper performance. Use a combination of nozzles and pressure designed to deliver thorough, even coverage of ASABE coarse spray. *Droplet spectrum recommendation for balance of drift & coverage.*

Example Spray Quality Chart by Type of Application

ASABE S-572.1 Classification Category	Color Code	Estimated VMD Range for Spray Quality*	Contact Insecticide & Fungicide	Systemic Insecticide & Fungicide	Contact Foliar Herbicide	Systemic Foliar Herbicide	Soil-Applied Herbicide	Incorporated Soil-Applied Herbicide	Fertilizer
Extremely Fine (XF)	Purple	Under 60							
Very Fine (VF)	Red	60-105							
Fine (F)	Orange	106-235							
Medium (M)	Yellow	236-340							
Coarse (C)	Blue	341-403							
Very Coarse (VC)	Green	404-502							
Extremely Coarse (XC)	White	503-665							
Ultra Coarse (UC)	Black	Over 665							

The above table provides general guidelines regarding droplet size and spray quality used in most spray applications.

It is always required that you carefully read and follow updated chemical manufacturers application label and instructions.

*NOTE: VMD range does not classify spray quality. Always ensure spray quality is followed first. VMD is a supplementary figure, and it is normal that nozzles with similar VMD can be classified into different spray qualities.

What about Multi-Tip Spraying? When to consider Double-Down & Angled Spraying

Potential problems with HIGH FLOW applications (15GPA+) with a single spray nozzle:

Spraying high volume out of a single tip can produce droplets that are “too large” to be effective for coverage, which make for less effective spray application.

Using multiple spray tips at the same time can provide substantial gains in effective coverage into crops or applications that otherwise would be very difficult to cover; **however**, multi-tip spraying should not be used without reason.

A typical time to use **Multi-Angle spraying**:

For improved coverage on a vertical growing target (e.g. wheat) when you are needing to paint both sides of the plant with fungicide. (e.g. Fusarium Head Blight)



A typical time to use **Double-Down spraying**:

For high rate applications that rely on consistent coverage in a dense canopy. Use a nozzle to produce a meaningful mix of coarser and finer spray to hit different levels of the canopy.



Pairing already-owned nozzles to make a dual nozzle pair:

Much of the time, an operator already has 1-2 nozzles on the sprayer that could be stacked as a pair, so it is an effective way to use existing nozzles to improve spray application with very little cost.

A First-timer's look at Tip Wizard



Back PWM / Search Tips / Results

Combo-Jet® DR110-05
Part No. 48201-05 Color Red
Screen No. 30 March 2022/03/05

Combo-Jet® MR110-04
Part No. 48201-04 Color Red
Screen No. 30 March 2022/03/05

Pres.	Speed	DOE	Class	VMD	<141	<600
(psi)	(ft/min)	(%)		(microns)	(%)	(%)
25	4.53-18.1	82%	VC	46µ	3%	78%
30	4.96-19.9	75%	VC	42µ	4%	82%
35	5.39-21.4	70%	VC	38µ	5%	86%
40	5.73-22.9	66%	C	36µ	6%	88%
45	6.08-24.3	62%	C	34µ	7%	90%
50	6.41-25.6	58%	C	32µ	8%	91%
55	6.75-26.9	56%	C	30µ	9%	92%
60	7.07-28.1	53%	C	29µ	9%	93%
65	7.39-29.2	51%	C	28µ	9%	94%
70	7.69-30.3	50%	C	27µ	10%	95%
75	7.98-31.4	48%	C	26µ	10%	95%
80	8.26-32.4	46%	C	25µ	11%	95%
85	8.53-33.4	45%	C	24µ	11%	96%
90	8.80-34.4	44%	C	23µ	12%	96%

Combo-Jet® DR110-04

Tip Wizard shows great info like:

- Adaptable Charts**
Adjusts to alternate units & spacing
Boom Pressure (PSI)
- Speed Range**
- Duty Cycle (for PWM)**
- Spray Quality**
For matching spray tips to chemical label requirements
- [Advanced] VMD (in µ)**
Median Droplet Diameter for comparing series of the same tip size
% of Volume < 141µ
For an estimate of driftable fines in ideal conditions
% of Volume < 600µ
For a relative factor of small droplets in ideal conditions

Have More Questions?
Talk to your Wilger dealer,
or call
CANADA 1 (833) 242-4121
USA 1 (877) 968-7695

Beginner's Guide to using Tip Wizard

- Choose application units, spray system type, and search function** (e.g. Search for tips)
- Enter application rate, spraying speed¹, nozzle spacing, and spray tip angle².**
¹Since PWM systems can modulate flow by changing the spray duration, enter the MAX typical spraying speed.
²Spray tip angle required is based on nozzle spacing and boom height. Always maintain 100% overlap.

3 Enter target spray quality or target droplet size (microns).
<This is where Tip Wizard gets more useful>
Each chemical used in agricultural spraying has different spray quality requirements for best efficacy and also to maintain tolerable levels of driftable fines for spraying in ideal conditions. Using the droplet size (VMD) allows a more advanced way to filter through series of tips.

Where to find target spray quality or droplet size?
Depending on the chemical, as well as the different methods and modes of applications, some chemical labels may have less/more information. In general, chemical labels will have a description of how it should be applied, in the form of an ASABE spray classification recommendation, or a minimum spray classification (e.g. Spray at least ASABE Coarse)

Application Information: Minimum water requirement on chemical label by law Reference max pressure for conventional nozzles like ER series
 • Water Volume: Minimum 22 L per acre.
 • Nozzles and Pressure: 30 to 40 psi (210 to 275 kPa) when using conventional flat fan nozzles.
 Low drift nozzles may require higher pressures for proper performance. Use a combination of nozzles and pressure designed to deliver thorough, even coverage of ASABE coarse spray.
 Spray Categories as per ASABE S572.1 Classification
 ■ Extremely Fine ■ Very Fine ■ Fine ■ Medium ■ Coarse ■ Very Coarse □ Extremely Coarse ■ Ultra Coarse

For the example chemical label application information, we'd have a classification of COARSE droplet size to follow. Considering the mode of application as well as the action (e.g. systemic herbicide vs. contact herbicide), you can choose the spray quality that would suit your conditions as best as possible. REMEMBER: the larger the droplet size/VMD, the coarser the spray, resulting in less coverage.
For advanced users, using a VMD droplet size can further filter into a spray quality to make it easier to compare one series to another.
For an example, we might find we typically have windier conditions, so try filter our results to stay around 375µ-400µ for our targeted droplet size.

- Select the Best Spray Tip for your needs.**
Based on the operating speed, pressure, spray quality, and while also gauging the last few columns (VMD, % drift, % of small droplets for coverage), make a selection.

Picking Spray Tips for Auto-Rate Controlled Sprayers

- STEP 1: Size Your Tip** Since the application rate must be consistent, selecting a tip sized to the required rate over the actual sprayer speed range is critical. It is recommended to use Tip Wizard, as it will adjust the chart specifically for any application rate, not just common pairs of rate & speed.

FOCUS ON: SPEED & PRESSURE for a required APPLICATION RATE

Speed and pressure dictate a spray tip's ability to match a rate, and we must ensure our typical travel speed follows a reasonable pressure range. Meet your minimum speed (e.g. turning) within the operational pressure range. Having pressure too low in slow spots can lead to spotty coverage. Once you have referenced your chart to find your applied rate to your speed, you will find a certain nozzle size will be most effective.

***FOR PWM SPRAYERS (DUTY CYCLE):** Since you have more control of your pressure, your sprayer will typically allow for a wider selection of tip size. Try to pick a size that allows a duty cycle of 60-80% at your typical sprayer speed, allowing sufficient speed up/down.

- STEP 2: Filter to Your Spray Quality** Each chemical will require a nozzle spray quality (for labels that do not, consult chemical representative or agronomist, or general guide based on mode of action), since you have selected your tip size (e.g. 110-04) you can now find the best option within the series available in that nozzle size. The ER/SR/MR/DR/UR series differ based on spray quality & drift reduction.

FOCUS ON: 'ASABE S572' SPRAY CLASSIFICATION

Since the pressure is dictating the spray quality, you'll want to filter out any tip series that cannot apply the recommended spray quality.

***FOR PWM SPRAYERS (Pressure Selection):** Your spray quality can be changed with changing of sprayer pressure. This means instead of maintaining the required quality through a fixed operating pressure range, you can maintain a more flexible pressure range (provided duty cycle is OK).

- STEP 3: Double Check** It is worthwhile to review extra information provided for the spray tip, and re-evaluate if necessary. While the extra information in extrapolated from lab conditions without active ingredients, and cannot be considered actual, but it does lend to paint a picture of differences between series.

[ADVANCED] FOCUS ON: Spray % <141µ, Spray % <600µ, VMD (µ)

The extra columns reinforce the different spray qualities between different series, but also give the ability to make a rough spray plan for managing real life spraying conditions.

Spray % <141µ: % of total spray that can be considered driftable fines. In ideal conditions, it would be reasonable to assume this spray is NOT going where you want it to go. Due to evaporation before absorption, off-target spray or inversion, very small droplets will not likely hit target. Ideally have a spray tip that minimizes driftable fines, BUT ensure you maintain an acceptable level of coverage.

As speed, wind conditions & boom height increase, observed spray drift will increase substantially.

Spray % <600µ: % of total spray that can be considered small droplets. As % of these useful droplets lowers, coverage is reduced. Consider it the 'other half' of the spray application, focusing on small droplets for coverage. Whereas you should maintain a low %<141µ, try to keep a %<600µ as high as possible, to maintain better coverage. As a very rough guideline with some usually chemical applications, aim for ~80+% <600µ for systemic applications; or ~90+% <600µ for contact applications; provided drift reduction levels are met and are satisfactory.

VMD (µ): The volumetric median diameter is the middle-point of spray distribution, and can be used to estimate between different series of the same size spray tips (tested on the same laboratory equipment). It is not for comparing between brands of tips. If you are familiar with using a VMD in tip searches, you can use it as an intensive filter to further focus in on tips that might work for your application. For example, if you are happy with spray application with the MR110-04 at 50PSI (346µ VMD), the spray quality might be comparable to an SR110-06 at 50 PSI (337µ VMD). Bear in mind, VMD is used for educational purposes only, and should not dictate application.

For more Guides, Videos & Reading on proper nozzle selection, visit www.wilger.net

We aim to have all sorts of ways to help make the best educated decision in picking and using spray tips, so if there is something you find would be helpful, don't hesitate to reach out and ask. Often, we cannot provide EVERYTHING there is to know in our guides, as it can be overwhelming, so if you are wanting to get more information from an expert, contact WILGER.

Picking Spray Tips for Pulse Width Modulation (PWM) Sprayers

NOTE: PWM Spray systems differ in some respects (max flow capacity, pulse frequency (Hz), and other general variations in operation. This guide is a general guide that applies to most PWM spray systems, but for clarification would be based on a 10Hz solenoid, with a relative max flow capacity of 1.5 us gpm (this determines the relative pressure drop). Wilger does not own, produce, or have any ownership of PWM spray systems. All rights reserved by their owners.

STEP 1: Size Your Tip Since the application rate must be consistent, selecting a tip sized to the required rate over the actual sprayer speed range is critical. It is recommended to use Tip Wizard, as it will adjust the chart specifically for any application rate.

Since PWM sprayers have control of sprayer pressure, a PWM sprayer will typically allow for a wider selection of tip sizes.

FOCUS ON: SPEED, PRESSURE & DUTY CYCLE (DC%) for a required APPLICATION RATE

Speed, pressure and respective duty cycle dictate a spray tip's ability to match a rate, and we must ensure our typical travel speed follows a reasonable pressure range. Having duty cycles <50% can degrade spray quality and consistency of spray swath, so it is always recommended to be above that.

Try to pick a size that allows a duty cycle of 60-80% at your typical sprayer speed, allowing sufficient speed up/down. If a nozzle is approaching 90-100% at your maximum sprayer speed at your highest pressures, this can be a good indication that a nozzle is sufficiently sized.

Before you look at any coverage/spray quality characteristics of a nozzle, you should have solidified which nozzle SIZE will work best first.

STEP 2: Filter to Your Spray Quality Each chemical will require a nozzle spray quality (for labels that do not, consult chemical representative or agronomist, or general guide based on mode of action), since you have selected your tip size (e.g. 110-04) you can now find the best option within the series available in that nozzle size. The ER/SR/MR/DR/UR series differ based on spray quality & drift reduction.

FOCUS ON: 'ASABE S572' SPRAY CLASSIFICATION

Since the pressure is dictating the spray quality, you'll want to filter out any tip series that cannot apply the recommended spray quality. Since PWM gives full control of sprayer pressure, this will usually filter the results to 1-2 nozzles within a size or series.

STEP 3: Pick your most flexible spray nozzle It is worthwhile to review extra information provided for the spray tip, and re-evaluate if necessary. While the extra information in extrapolated from lab conditions without active ingredients, and cannot be considered actual, but it does lend to paint a picture of differences between series.

The goal is to select a nozzle that can be applied at relatively moderate pressures (e.g. 50-60PSI) when spray conditions are ideal, giving a means to reduce pressure to 30-40PSI to have a 'drift reduction mode' that can be called upon when less ideal conditions arrive.

[ADVANCED] FOCUS ON: Spray % <141µ, Spray % <600µ, VMD (µ)

The extra columns reinforce the different spray qualities between different series, but also give the ability to make a rough spray plan for managing real life spraying conditions.

Spray % <141µ: % of total spray that can be considered driftable fines. In ideal conditions, it would be reasonable to assume this spray is NOT going where you want it to go. Due to evaporation before absorption, off-target spray or inversion, very small droplets will not likely hit target. Ideally have a spray tip that minimizes driftable fines, BUT ensure you maintain an acceptable level of coverage.

As speed, wind conditions & boom height increase, observed spray drift will increase substantially. With wind speeds of 12mph+, it can be expect to have driftable fine spray double. Windy conditions, higher drift sensitivity, and other environmental reasons are serious considerations for what might be an acceptable level of driftable fines.

By general chemical mode of action, you might have a reference point for % driftable fines, which might be generalized as:

Systemic Herbicides: Try maintain driftable fines <10%. (For very sensitive applications and herbicides, the requirement might go down to even 1.5-5%)

Contact Herbicides & Fungicides: Try maintain driftable fines <15%. This allows for a consistent and high level of coverage without losing a great deal to driftable fines. It is often part of a good balance between driftable fines and coverage.

Spray % <600µ: % of total spray that can be considered small droplets. As % of these useful droplets lowers, coverage is reduced.

Consider it the 'other half' of the spray application, focusing on small droplets for coverage. Whereas you should maintain a low %<141µ, try to keep a %<600µ as high as possible, to maintain better coverage. As a very rough guideline with some usually chemical applications, aim for ~80+% <600µ for systemic applications; or ~90+% <600µ for contact applications; provided drift reduction levels are met and are satisfactory.

VMD (µ): The volumetric median diameter is the middle-point of spray distribution, and can be used to estimate between different series of the same size spray tips (tested on the same laboratory equipment). It is not for comparing between brands of tips. If you are familiar with using a VMD in tip searches, you can use it as an intensive filter to further focus in on tips that might work for your application. For example, if you are happy with spray application with the MR110-04 at 50PSI (346µ VMD), the spray quality might be comparable to an SR110-06 at 50 PSI (337µ VMD). Bear in mind, VMD is used for educational purposes only, and should not dictate application.

Quick-Start Example: 10 US GPA @ 14 MPH, on 20" spacing, with a PWM Spray System, applying SYSTEMIC HERBICIDE (glyphosate)

STEP 1: SIZE THE TIP: Focus on Pressure/Speed Range/Duty Cycle (Try maintain 60-80% duty cycle through full speed/pressure range)

For the best option for a tip size, it'd likely be the 110-06 size. (110-05 falls short of nozzle size, and 110-08 starts getting too large)

It would apply 10 US GPA, 14MPH anywhere between 30-60PSI PSI, allowing more than enough room into turn situations if turn compensation is available.

STEP 2: QUALIFY THE SPRAY

Since the chemical label for glyphosate requires a 'even coverage of ASABE COARSE droplets', we will notice the ER110-06 is too fine, the SR fits just right, and the MR/DR are a fair bit coarser than required. We could also use a VMD of 400µ to filter out more.

Note: The MR & DR series are coarser than required, but might be suitable for applicators who have to apply into more drift-sensitive areas.

For this example, we will single out the SR110-06 as our best tip series.

STEP 3: DOUBLE CHECK SR110-06 for max flexibility between

'IDEAL SPRAYING MODE' & 'DRIFT REDUCTION MODE'

Ideal Condition Spraying @ 14MPH:

Drift Sensitive Spraying @ 14MPH:

@50PSI: DUTY CYCLE: 75%  Excellent

@35PSI: DUTY CYCLE: 90%  OK

@50PSI: COARSE Spray Class

@35PSI: VERY COARSE Spray Class

@50PSI % < 141µ: ~9%  Good

@35PSI % < 141µ: ~6%  Excellent

@50PSI % < 600µ: ~90%  Excellent

@35PSI % < 600µ: ~84%  Very Good

Further considerations: Given the high level of coverage at higher pressures (50PSI+), this same nozzle could be used for contact herbicides and fungicides to cover more applications.

Combo-Jet® SR110-06
Part No: 40287-06 Color: Gray
Screen No: Not Required

Pressure (psi) ↓	Speed Range (mph) ↓	DC (%) @ 14 mph	Class	VMD (µ) ↓	<141 (%) ↓	<600 (%) ↓
25	3.3-13.2	>100	XC	466µ	3	76
30	3.6-14.4	97	VC	438µ	5	81
35	3.9-15.6	90	VC	414µ	6	84
40	4.2-16.6	84	C	393µ	7	87
45	4.4-17.6	80	C	375µ	8	88
50	4.7-18.6	75	C	358µ	9	90
55	4.9-19.5	72	C	344µ	10	91
60	5.1-20.4	69	C	330µ	11	92

Picking Nozzles for Dual-tip Spraying

Picking two spray tips isn't much different than a single tip. Since the sprayer has some means of adjust the flow to match a flow rate, simply pick a nozzle size that would supply the full rate, and then divide it into parts that would provide the same flow rate.

For example: If a 110-10 nozzle size is required for an application, suitable pairs would be like a '110-06 + 110-04' or '110-05 + 110-05', as the cumulative size would be able to apply the same rate as a single 110-10. For consistency, limit the size difference to two nozzle sizes to ensure consistent back pressure between both nozzles. (e.g. 110-08 + 110-02 would not be ideal as the -08 might steal flow from the -02)

1 STEP 1: Size Your Tip Since the application rate must be consistent, selecting a tip sized to the required rate over the actual sprayer speed range is critical. It is recommended to use Tip Wizard, as it will adjust the chart specifically for any application rate, not just common pairs of rate & speed.

FOCUS ON: SPEED & PRESSURE for a required APPLICATION RATE

***FOR PWM SPRAYERS (DUTY CYCLE):** Since you have more control of your pressure, your sprayer will typically allow for a wider selection of tip size. Try to pick a size that allows a duty cycle of 60-80% at your typical sprayer speed, allowing sufficient speed up/down.

2 STEP 2: Filter to Your Spray Quality Each chemical will require a nozzle spray quality (for labels that do not, consult chemical representative or agronomist, or general guide based on mode of action), since you have selected your tip size (e.g. 110-04) you can now find the best option within the series available in that nozzle size. The ER/SR/MR/DR/UR series differ based on spray quality & drift reduction.

Example: **MR110-04 + MR110-02**
Spray Quality: **Coarse***

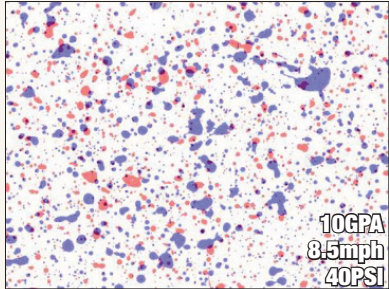

Example: **2x SR110-03**
Spray Quality: **Coarse***

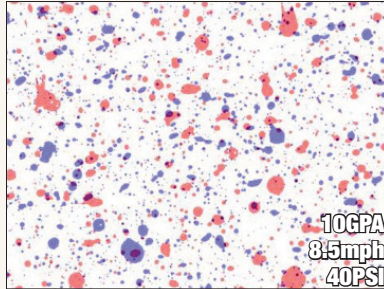

Single Tip Example: **SR110-06**
Spray Quality: **Coarse***

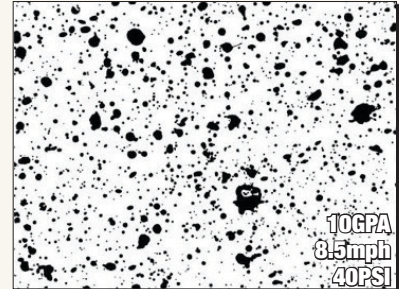

***IMPORTANT: FOR PWM SPRAYERS (Pressure-drop through solenoid):** Depending on the solenoid used, for larger nozzle sizes (or cumulative nozzle sizes for double-down nozzles) there will be greater pressure drop. So, when considering spray quality for the smaller nozzles in a pair, verify the pressure drop for the cumulative size as it will differ from the nozzles individually. With the pressure drop factor, cross-reference the spray quality of the smaller nozzles in the pair for their more realistic spray quality (after pressure drop).

3 STEP 3: Double Check Just like the 'Quick-start guide to picking spray tips', refer to the extra information to qualify nozzles to ensure they will suit your application. Since the pair of nozzles are spraying a fraction of the total weight, there is some synergy between having one as a finer nozzle and the other coarser to produce a more meaningful mix of spray droplet sizes to get where they need to go.

[ADVANCED] FOCUS ON: Spray % <141µ, Spray % <600µ, VMD (µ)

The extra columns reinforce the different spray qualities between different series, but also give the ability to make a rough spray plan for managing real life spraying conditions.

Spray % <141µ: % of total spray that can be considered driftable fines. If one nozzle is producing more driftable fines than the other, but when averaging based on the flow, you'd want to ensure you are still at a tolerable driftable fines % given the application.

As speed, wind conditions & boom height increase, observed spray drift will increase substantially. This is especially the case with forward/backward facing nozzles.

Spray % <600µ: % of total spray that can be considered small droplets. As % of these useful droplets lowers, coverage is reduced.

Since you are splitting a single 'large' nozzle into two smaller nozzles, you should take advantage of getting a much higher %<600µ than possible with a single nozzle.

VMD (µ): As VMD is the middle point in the distribution of spray, and a pair of nozzles will have a blended VMD when both are considered, simply qualify a tip based on acceptable spray quality first, and take note of the two nozzles and

EXAMPLE: 20 US GPA Glufosinate (Contact Herbicide), on 20" spacing, traveling 12 mph, using a PWM spray system

STEP 1: Using Tip Wizard (or nozzle charts), a 110-125 nozzle size would suffice for travel speed and pressure range. The ER110-125 is shown as an example. With this 110-125 nozzle size, we know a nozzle pair adding to a ~110-125 would be suitable for the application rate. (e.g 110-06 + 110-06) With this, split the nozzle size into portions and search for a '10 GPA' nozzle and '10GPA' nozzle for example, based on a fraction of total flow.

NOTE: There is extra pressure drop through a solenoid, so keep that in mind when selecting nozzles as the spray quality will differ from nozzles operating by themselves.

Combo-Jet® ER110-125
Part No: 40281-125 Color: Teal
Screen No: Not Required

Pressure (psi)	Speed Range (mph)	DC (%) @ 12 mph	Class	VMD (µ)	<141 (%)	<600 (%)
20	2.4-10.2	>100	XC	467µ	7	58
25	2.9-11.4	>100	XC	447µ	8	64
30	3.1-12.5	96	XC	430µ	8	68
35	3.4-13.5	89	XC	416µ	9	71
40	3.6-14.5	83	XC	403µ	9	73
45	3.8-15.3	78	XC	392µ	10	75
50	4.0-16.2	74	XC	383µ	10	77
55	4.2-17.0	71	VC	374µ	11	78
60	4.4-17.7	68	VC	366µ	11	79
65	4.6-18.4	65	VC	358µ	11	80

STEP 2: By chemical label, Glufosinate is to be applied as a ASABE medium spray quality or coarser. Qualify spray nozzles suitable for chemical label requirement.

STEP 3: Qualify nozzle pair based on spray quality, and pick based on most suitable % driftable fines (ideally <15%) and % coverage (ideally >90%)

Combo-Jet® SR110-06
Part No: 40287-06 Color: Gray
Screen No: Not Required

Pressure (psi)	Speed Range (mph)	DC (%) @ 12 mph	Class	VMD (µ)	<141 (%)	<600 (%)
25	2.7-11.0	>100	XC	466µ	3	76
30	3.0-12.0	100	VC	438µ	5	81
35	3.2-13.0	92	VC	414µ	6	84
40	3.5-13.9	86	C	393µ	7	87
45	3.7-14.7	82	C	375µ	8	88
50	3.9-15.5	77	C	358µ	9	90
55	4.1-16.3	74	C	344µ	10	91
60	4.2-17.0	71	C	330µ	11	92
65	4.4-17.7	68	C	318µ	11	93

Example Result:
Double-Down SR110-06 would provide upwards of 10%+ more volume made of small droplets, without increasing driftable fines.

The spray quality is within the 'coarse' spray quality, just outside MEDIUM spray quality. An ER series could be substituted to provide a mix of even finer spray into the dual nozzle setup.

Total flow would be the same as a 110-12, which would be nominally smaller than a 110-125.

COMBO-JET ER Series Spray Tips

The ER series spray tip is a conventional flat fan nozzle, emphasizing consistent spray pattern with relatively fine spray. All ER nozzles are manufactured with a stainless steel tip.



Longer Lasting Stainless Tips



Less Plugged Nozzles



Perfect for PWM Sprayers



Consistent Pattern at Lower PSI



Solid Mass Spray Droplets



Acid Resistant Nozzles

A DETAILED LOOK AT: **ER110-06**



Balance of Drift Control & Coverage



ER110-06 Droplet Distribution Example (40PSI)

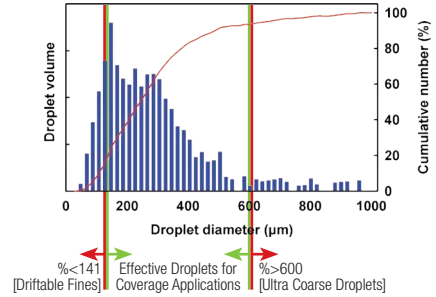

ER series is designed to produce finer spray with a consistent pattern.

COMBO-JET® ER80° ASABE S572.1 Spray Quality Chart

Pressure (psi)	20	25	30	35	40	45	50	60	65	70	80
ER80-01	F	F	F	F	F	F	F	F	F	F	F
ER80-015	F	F	F	F	F	F	F	F	F	F	F
ER80-02	F	F	F	F	F	F	F	F	F	F	F
ER80-025	M	M	F	F	F	F	F	F	F	F	F
ER80-03	M	M	F	F	F	F	F	F	F	F	F
ER80-04	M	M	M	M	M	F	F	F	F	F	F
ER80-05	C	C	M	M	M	M	M	M	M	F	F
ER80-06	C	C	C	C	C	C	M	M	M	M	M
ER80-08	VC	C	C	M	M	M	M	F	F	F	F
ER80-10	XC	XC	XC	VC	C	C	C	M	M	M	F
ER80-125		XC	XC	VC	VC	C	C	C	C	C	M
ER80-15		XC	XC	XC	VC	C	C	C	M	M	M
ER80-20		UC	XC	XC	XC	XC	VC	C	C	C	C
ER80-25		UC	XC	XC	XC	VC	VC	C	C	C	C
ER80-30		UC	UC	XC	XC	XC	XC	XC	XC	VC	VC
ER80-40				XC	XC	XC	XC	XC	XC	XC	VC
ER80-50				XC	XC	XC	XC	XC	XC	XC	VC
ER80-60				XC	XC	XC	XC	XC	XC	XC	VC

COMBO-JET® ER Series Specifications

Approved for PWM Spray Systems
Compatible with all PWM Spray systems/Hz.

Operating Pressure
20-100PSI

Flat Fan Nozzle Type
Conventional Flat Fan

Nozzle Materials
Spray Tip: Stainless Steel
O-ring: FKM, 13mm x 3mm #40260-00 (viton avail.)
Cap: Glass-reinforced Polypropylene

ASABE Spray Classification

(ASABE S572.1 Standard)
Spray quality is categorized based on Dv0.1 and VMD droplet sizes. Objective testing data (by 3rd party), from spray spectrum recording equipment (without wind tunnel use), has been used to classify spray quality for this chart. Chart shown includes spray quality at tested data points as well as extrapolated data points.

- Orange: Fine (F)
- Yellow: Medium (M)
- Blue: Coarse (C)
- Green: Very Coarse (VC)
- White: Extremely Coarse (XC)
- Black: Ultra Coarse (UC)

Tips sized up to 110-06 verified on Phase Doppler Particle Analyzer (PDPA); tips sized over 110-06 verified on Malvern.

Optimal Spray Tip Height

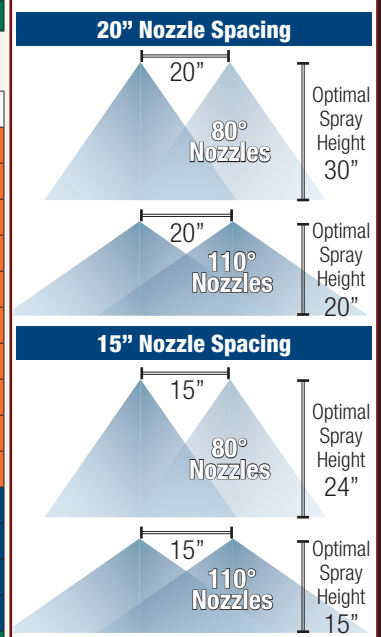

COMBO-JET® ER110° ASABE S572.1 Spray Quality Chart

Pressure (psi)	20	25	30	35	40	45	50	60	65	70	80
ER110-01	F	F	F	F	F	F	F	F	F	F	F
ER110-015	F	F	F	F	F	F	F	F	F	F	F
ER110-02	F	F	F	F	F	F	F	F	F	F	F
ER110-025	F	F	F	F	F	F	F	F	F	F	F
ER110-03	F	F	F	F	F	F	F	F	F	F	F
ER110-04	M	M	M	M	F	F	F	F	F	F	F
ER110-05	M	M	M	M	F	F	F	F	F	F	F
ER110-06	C	M	M	M	M	M	M	M	M	F	F
ER110-08	C	C	C	M	M	M	M	F	F	F	F
ER110-10	VC	C	C	C	C	C	M	M	M	M	F
ER110-125		XC	XC	XC	VC	VC	C	C	C	C	C
ER110-15		XC	XC	XC	VC	VC	C	C	C	C	C
ER110-20		XC	XC	XC	XC	XC	XC	XC	VC	VC	C
ER110-25		XC	XC	XC	XC	XC	XC	XC	VC	VC	C
ER110-30		UC	XC	XC	XC	XC	XC	XC	XC	XC	VC

COMBO-JET SR Series Spray Tips

The SR series spray tip is a closed-chamber, pre-orifice drift reduction nozzle, emphasizing a first stage of drift reduction. The SR series balances excellent coverage spray with significant drift reduction upwards of 50%+.



Longer Lasting Stainless Tips



Less Plugged Nozzles



Perfect for PWM Sprayers



Consistent Pattern at Lower PSI



Solid Mass Spray Droplets



Acid Resistant Nozzles

A DETAILED LOOK AT: **SR110-06**



Balance of Drift Control & Coverage

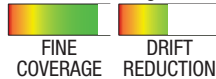

SR110-06 Droplet Distribution Example (40PSI)

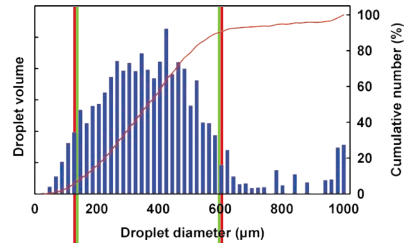

%<141 (Driftable Fines) Effective Droplets for Coverage Applications %>600 (Ultra Coarse Droplets)

SR series droplet distribution balances excellent fine spray coverage while reducing driftable fines.

COMBO-JET® SR80° ASABE S572.1 Spray Quality Chart

Pressure (psi)	25	30	35	40	45	50	60	65	70	80
SR80-01	M	M	F	F	F	F	F	F	F	F
SR80-015	C	M	M	M	M	F	F	F	F	F
SR80-02	C	M	M	M	M	M	F	F	F	F
SR80-025	C	C	C	M	M	M	M	M	M	F
SR80-03	C	C	C	C	C	C	M	M	M	M
SR80-04	C	C	C	C	C	C	C	M	M	M
SR80-05	VC	VC	C	C	C	C	C	C	C	C
SR80-06	XC	VC	VC	VC	C	C	C	C	C	C
SR80-08	UC	UC	UC	UC	XC	XC	XC	XC	XC	XC
SR80-10	UC	UC	UC	UC	UC	UC	XC	XC	XC	XC
SR80-125	UC	UC	UC	UC	UC	UC	UC	XC	XC	XC
SR80-15	UC	UC	UC	UC	UC	UC	UC	UC	UC	UC
SR80-20		UC	UC	UC	UC	UC	UC	UC	UC	UC
SR80-25		UC	UC	UC	UC	UC	UC	UC	UC	UC
SR80-30		UC	UC	UC	UC	UC	UC	UC	UC	UC

COMBO-JET® SR Series Specifications

Approved for PWM Spray Systems
Compatible with all PWM Spray systems/Hz.

Operating Pressure
25-100PSI

Flat Fan Nozzle Type
Closed-Chamber, Pre-Orifice Drift Reduction

Nozzle Materials
Spray Tip: Stainless Steel
O-ring: FKM, 13mm x 3mm #40260-00 (viton avail.)
Cap: Glass-reinforced Polypropylene

ASABE Spray Classification

(ASABE S572.1 Standard)
Spray quality is categorized based on Dv0.1 and VMD droplet sizes. Objective 3rd party testing data, from spray spectrum recording equipment (without wind tunnel use), has been used to classify spray quality for this chart. Chart shown includes spray quality at tested data points as well as extrapolated data points.

- Fine (F)
- Medium (M)
- Coarse (C)
- Very Coarse (VC)
- Extremely Coarse (XC)
- Ultra Coarse (UC)

Tips sized up to 110-06 verified on Phase Doppler Particle Analyzer (PDPA); tips sized over 110-06 verified on Malvern.

COMBO-JET® SR110° ASABE S572.1 Spray Quality Chart

Pressure (psi)	25	30	35	40	45	50	60	65	70	80
SR110-015	M	F	F	F	F	F	F	F	F	F
SR110-02	M	M	F	F	F	F	F	F	F	F
SR110-025	M	M	M	M	M	F	F	F	F	F
SR110-03	C	C	C	C	M	M	M	M	M	F
SR110-04	C	C	C	C	C	M	M	M	M	M
SR110-05	C	C	C	C	C	C	C	M	M	M
SR110-06	VC	VC	C	C	C	C	C	C	C	M
SR110-08	UC	XC	XC	XC	XC	VC	C	C	C	C
SR110-10	UC	XC	XC	XC	XC	XC	VC	C	C	C
SR110-125	UC	UC	XC	XC	XC	XC	XC	VC	C	C
SR110-15	UC	UC	UC	UC	XC	XC	XC	XC	XC	XC
SR110-20		UC	UC	XC	XC	XC	XC	XC	XC	XC
SR110-25		UC	UC	XC	XC	XC	XC	XC	XC	XC

Optimal Spray Tip Height

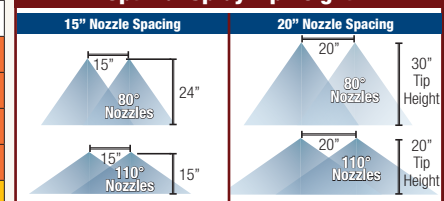

LERAP Ratings for SR Series As of January 2021

SR110-05	★★★★75%	★★★50%
	1.0-1.5BAR	1.6-3.0BAR

For the updated list of nozzles, visit www.wilger.net/LERAP
More information on LERAP certification, process, and the most up to date listing of approved nozzles and their ratings, is available from the Health and Safety Executive (HSE), also available online @ <https://secure.pesticides.gov.uk/SprayEquipment>

COMBO-JET® SR Pre-orifices - by nozzle size [Replacement Only]

-01	-015	-02	-025	-03	-04	-05	-06	-08	-10	-125	-15	-20	-25	-30
40285-01	40285-015	40285-01	40285-025	40285-03	40285-04	40285-05	40285-06	40285-08	40285-10	40285-125	40285-15	40285-20	40285-25	40285-30

COMBO-JET MR Series Spray Tips

The MR series spray tip is a closed-chamber, pre-orifice drift reduction nozzle, emphasizing a second stage of drift reduction. The MR series balances great coverage spray with significant drift reduction upwards of 75%+.



Longer Lasting Stainless Tips



Superior Drift Reduction



Perfect for PWM Sprayers



Consistent Pattern at Lower PSI



Solid Mass Spray Droplets



Acid Resistant Nozzles

A DETAILED LOOK AT: **MR110-06**



Balance of Drift Control & Coverage



MR110-06 Droplet Distribution Example (40psi)

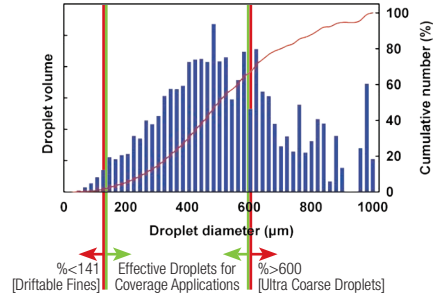

MR series is designed to produce relatively coarse spray with minimal drift.

COMBO-JET® MR80° ASABE S572.1 Spray Quality Chart

Pressure (psi)	30	35	40	45	50	60	65	70	80
MR80-005	M	M	F	F	F	F	F	F	F
MR80-0067	F	F	F	F	F	F	F	F	F
MR80-01	M	F	F	F	F	F	F	F	F
MR80-015	C	C	C	M	M	M	M	M	F
MR80-02	C	C	C	C	C	M	M	M	M
MR80-025	VC	VC	C	C	C	C	C	C	C
MR80-03	VC	VC	C	C	C	C	C	C	C
MR80-04	VC	VC	C	C	C	C	C	C	C
MR80-05	XC	XC	VC	VC	VC	VC	C	C	C
MR80-06	XC	XC	XC	XC	VC	VC	VC	VC	C
MR80-08	UC	UC	UC	UC	XC	XC	XC	XC	VC
MR80-10	UC	UC	UC	UC	UC	XC	XC	XC	XC
MR80-125	UC	UC	UC	UC	UC	UC	UC	XC	XC
MR80-15	UC	UC	UC	XC	XC	XC	XC	XC	VC
MR80-20		UC	UC	UC	UC	XC	XC	XC	XC
MR80-25		UC	UC	UC	UC	UC	UC	UC	UC
MR80-30		UC	UC	UC	UC	UC	UC	UC	UC
MR80-40		UC	UC	UC	UC	XC	XC	XC	XC

COMBO-JET® MR110° ASABE S572.1 Spray Quality Chart

Pressure (psi)	30	35	40	45	50	60	65	70	80
MR110-015	C	C	C	M	M	M	F	F	F
MR110-02	C	C	C	M	M	M	M	M	F
MR110-025	C	C	C	C	C	C	M	M	M
MR110-03	VC	C	C	C	C	C	C	C	C
MR110-04	VC	VC	C	C	C	C	C	C	C
MR110-05	XC	XC	VC	VC	VC	C	C	C	C
MR110-06	XC	XC	XC	VC	VC	VC	VC	VC	C
MR110-08	UC	UC	UC	XC	XC	XC	XC	XC	VC
MR110-10	UC	UC	XC	XC	XC	XC	XC	XC	VC
MR110-125	UC	UC	UC	UC	UC	UC	UC	UC	UC
MR110-15	UC	UC	UC	UC	UC	UC	UC	UC	UC
MR110-20		UC	UC	UC	UC	UC	UC	UC	XC

COMBO-JET® MR Series Specifications

Approved for PWM Spray Systems
Compatible with all PWM Spray systems/Hz.

Operating Pressure
30-100PSI

Flat Fan Nozzle Type
Closed-Chamber, Pre-Orifice Drift Reduction

Nozzle Materials
Spray Tip: Stainless Steel
Repl.O-ring: FKM, 13mm x 3mm #40260-00 (viton avail)
Cap: Glass-reinforced Polypropylene

ASABE Spray Classification

(ASABE S572.1 Standard)
Spray quality is categorized based on Dv0.1 and VMD droplet sizes. Objective 3rd party testing data, from spray spectrum recording equipment (without wind tunnel use), has been used to classify spray quality for this chart. Chart shown includes spray quality at tested data points as well as extrapolated data points.

- Fine (F)
 - Medium (M)
 - Coarse (C)
 - Very Coarse (VC)
 - Extremely Coarse (XC)
 - Ultra Coarse (UC)
- Tips sized up to 110-06 verified on Phase Doppler Particle Analyzer (PDPA); tips sized over 110-06 verified on Malvern.

Optimal Spray Tip Height

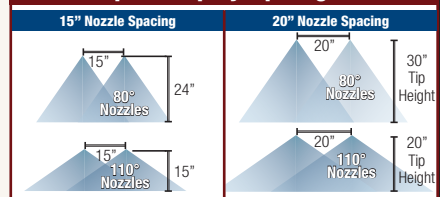

LERAP Ratings for MR Series As of January 2021

MR110-04	★★★★ 75%	☆☆ 50%
	1.0-2.5BAR	2.6-3.5BAR
MR110-05	☆☆☆☆ 90%	★★★★ 75%
	1.0-1.5BAR	1.6-5.0BAR
MR110-06	☆☆☆☆ 90%	★★★★ 75%
	1.0-1.5BAR	1.6-5.0BAR

For the updated list of nozzles, visit www.wilger.net/LERAP
More information on LERAP certification, process, and the most up to date listing of approved nozzles and their ratings, is available from the Health and Safety Executive (HSE), also available online @ <https://secure.pesticides.gov.uk/SprayEquipment>

JKI Nozzle Ratings for MRs
Visit www.wilger.net for updated charts

COMBO-JET® MR Pre-orifices - by size [Replacement Only]

	-005	-0067	-01	-015	-02	-025	-03	-04	-05	-06	-08	-10	-125	-15	-20	-25	-30	-40
	40285-005	40285-007	40285-01	40285-015	40285-01	40285-025	40285-03	40285-04	40285-05	40285-06	40285-08	40285-10	40285-125	40285-15	40285-20	40285-25	40285-30	40285-40

COMBO-JET DR Series Spray Tips

The DR series spray tip is a closed-chamber, pre-orifice drift reduction nozzle, emphasizing a third stage of drift reduction. The DR series balances good coverage spray with extremely low driftable fines, upwards of a 90% reduction in driftable fines.



Longer Lasting Stainless Tips



Superior Drift Reduction



Perfect for PWM Sprayers



Consistent Pattern at Lower PSI



Solid Mass Spray Droplets



Acid Resistant Nozzles

A DETAILED LOOK AT: **DR110-06**



Balance of Drift Control & Coverage

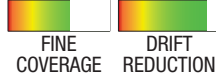

DR110-06 Droplet Distribution Example (40psi)

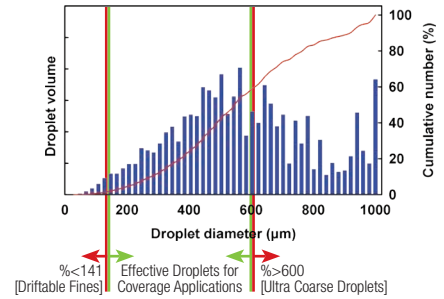

DR series is designed to produce extremely coarse spray with very minimal drift.

COMBO-JET® DR80° ASABE S572.1 Spray Quality Chart

Pressure (psi)	30	35	40	45	50	60	65	70	80
DR80-005	C	M	M	F	F	F	F	F	F
DR80-0067	C	C	M	M	M	M	F	F	F
DR80-01	C	C	C	M	M	M	M	F	F
DR80-015	VC	VC	C	C	C	C	C	C	C
DR80-02	XC	VC	VC	VC	VC	C	C	C	C
DR80-025	XC	VC	VC	VC	VC	C	C	C	C
DR80-03	XC	XC	VC	VC	VC	C	C	C	C
DR80-04	XC	XC	XC	XC	XC	XC	VC	VC	C
DR80-05	XC	XC	XC	XC	XC	XC	XC	VC	VC
DR80-06	XC	XC	XC	XC	XC	XC	XC	XC	XC
DR80-08	UC	UC	UC	UC	UC	UC	UC	UC	UC
DR80-10	UC	UC	UC	UC	UC	UC	UC	UC	UC
DR80-125	UC	UC	UC	UC	UC	UC	UC	UC	UC
DR80-15	UC	UC	UC	UC	UC	UC	UC	UC	UC
DR80-20		UC	UC	UC	UC	UC	UC	UC	UC
DR80-25		UC	UC	UC	UC	UC	UC	UC	UC
DR80-30		UC	UC	UC	UC	UC	UC	UC	XC

COMBO-JET® DR110° ASABE S572.1 Spray Quality Chart

Pressure (psi)	30	35	40	45	50	60	65	70	80
DR110-015	C	C	C	C	C	C	C	M	M
DR110-02	VC	VC	VC	C	C	C	C	C	C
DR110-025	VC	VC	VC	C	C	C	C	C	C
DR110-03	XC	XC	VC	VC	VC	C	C	C	C
DR110-04	XC	XC	VC	VC	VC	VC	C	C	C
DR110-05	XC	XC	XC	XC	XC	XC	XC	VC	VC
DR110-06	XC	XC	XC	XC	XC	XC	XC	XC	VC
DR110-08	UC	UC	UC	UC	UC	UC	UC	UC	XC
DR110-10	UC	UC	UC	UC	UC	UC	UC	UC	UC
DR110-125	UC	UC	UC	UC	UC	UC	UC	UC	UC
DR110-15	UC	UC	UC	UC	UC	UC	UC	UC	UC

COMBO-JET® DR Pre-orifices - by tip size [Replacement Only]

-005	-0067	-01	-015	-02	-025	-03	-04	-05	-06	-08	-10	-125	-15	-20	-25	-30
40285-005	40285-007	40285-01	40285-015	40285-01	40285-025	40285-03	40285-04	40285-05	40285-06	40285-08	40285-10	40285-125	40285-15	40285-20	40285-25	40285-30

COMBO-JET® DR Series Specifications

Approved for PWM Spray Systems
Compatible with all PWM Spray systems/Hz.

Operating Pressure
30-100PSI

Flat Fan Nozzle Type
Closed-Chamber, Pre-Orifice Drift Reduction

Nozzle Materials
Spray Tip: Stainless Steel
Repl.O-ring: FKM, 13mm x 3mm #40260-00 (viton avail)
Cap: Glass-reinforced Polypropylene

ASABE Spray Classification

(ASABE S572.1 Standard)
Spray quality is categorized based on Dv0.1 and VMD droplet sizes. Objective 3rd party testing data, from spray spectrum recording equipment (without wind tunnel use), has been used to classify spray quality for this chart. Chart shown includes spray quality at tested data points as well as extrapolated data points.

- Fine (F)
- Medium (M)
- Coarse (C)
- Very Coarse (VC)
- Extremely Coarse (XC)
- Ultra Coarse (UC)

Tips sized up to 110-06 verified on Phase Doppler Particle Analyzer (PDPA); tips sized over 110-06 verified on Malvern.

Optimal Spray Tip Height

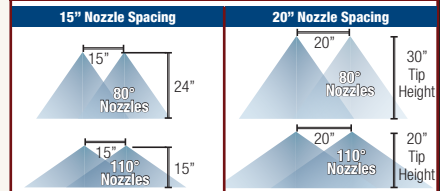

LERAP Ratings for DR Series As of January 2021

DR110-025	★★★★ 75%	☆☆ 50%
	1.0-2.5BAR	2.6-3.5BAR
DR110-03	☆☆☆☆ 90%	★★★★ 75%
	1.0-1.5BAR	2.6-3.5BAR
DR110-04	★★★★ 75%	
	1.0-5.0BAR	
DR110-05	☆☆☆☆ 90%	★★★★ 75%
	1.0-1.5BAR	1.6-5.0BAR
DR110-06	☆☆☆☆ 90%	★★★★ 75%
	1.0-3.0BAR	3.1-5.0BAR

For the updated list of nozzles, visit www.wilger.net/LERAP
More information on LERAP certification, and the most up to date listing of tested nozzles, visit <https://secure.pesticides.gov.uk/SprayEquipment>

JKI Nozzle Ratings for DR Series Visit www.wilger.net for updated charts

COMBO-JET UR Series* Spray Tips

*U.S. Patent No. 10,603,681

The UR series spray tip is a dual-chamber, pre-orifice drift reduction nozzle, emphasizing the coarsest stage of drift reduction. The UR series is heavily suited to ultra-low driftable fines, emphasizing drift reduction over coverage.



Approved for Dicamba Mixes



Ultra Low Spray Drift



Perfect for PWM Sprayers



Longer Lasting Stainless Tips



Solid Mass Spray Droplets



Acid Resistant Nozzles

A DETAILED LOOK AT: **UR110-06**



Balance of Drift Control & Coverage

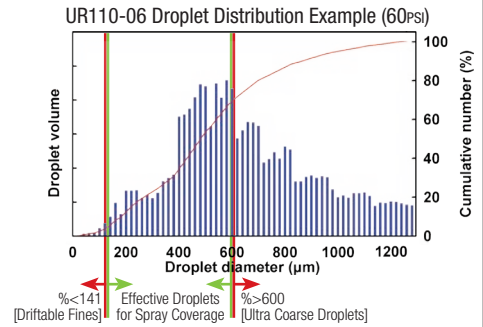

UR series is designed to produce ultra coarse spray with extremely little drift.

COMBO-JET® UR110° ASABE S572.1 Spray Quality Chart

Pressure (psi)	35	40	45	50	60	65	70	80
UR110-025	UC	UC	UC	UC	XC	XC	XC	XC
UR110-03	UC	UC	UC	UC	XC	XC	XC	XC
UR110-04	UC	UC	UC	UC	UC	UC	UC	UC
UR110-05	UC	UC	UC	UC	UC	UC	UC	UC
UR110-06	UC	UC	UC	UC	UC	UC	UC	UC
UR110-08	UC	UC	UC	UC	UC	UC	UC	UC
UR110-10	UC	UC	UC	UC	UC	UC	UC	UC

COMBO-JET® UR Series Specifications

Approved for PWM Spray Systems
Compatible with all PWM Spray systems/Hz.

Operating Pressure
35-100PSI

Flat Fan Nozzle Type
Dual Closed-Chamber, Pre-Orifice Drift Reduction

Nozzle Materials
Spray Tip: Stainless Steel
Repl.O-ring: FKM, 13mm x 3mm #40260-00 (viton avail)
Cap: Glass-reinforced Polypropylene

ASABE Spray Classification

(ASABE S572.1 Standard)
Spray quality is categorized based on Dv0.1 and VMD droplet sizes. Objective 3rd party testing data, from spray spectrum recording equipment (without wind tunnel use), has been used to classify spray quality for this chart. Chart shown includes spray quality at tested data points as well as extrapolated data points.

- Fine (F)
- Medium (M)
- Coarse (C)
- Very Coarse (VC)
- Extremely Coarse (XC)
- Ultra Coarse (UC)

UR Nozzles verified on Malvern.

COMBO-JET® UR Series* Pre-orifice Sets [Replacement only]

UR two-piece pre-orifices must be replaced with a new pair only. Correct orifices must be used for proper performance.

-025	-03	-04	-05	-06	-08	-10
40292-22	40292-23	40292-24	40292-25	40292-26	40292-28	40292-30

*U.S. Patent No. 10,603,681

JKI Ratings for UR Series

As of January 2021

UR Series	75%	50%
UR110-04	2.0-3.0BAR REF. G-2184	4.0-6.0BAR REF. G-2184
UR110-05	90% 2.0BAR REF. G-2185	75% 3.0-6.0BAR REF. G-2185
UR110-06	90% 2.0-3.0BAR REF. G-2189	75% 4.0-6.0BAR REF. G-2189

Optimal Spray Tip Height

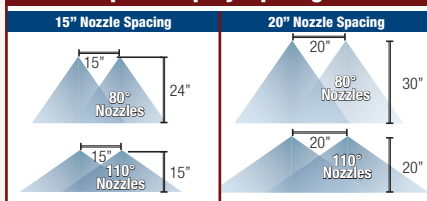

COMBO-JET 80° Spray Tips - Standard Sprayer Systems

Comprehensive rate & speed charts for any nozzle spacing/speed/rate is available on Tip Wizard. Try it today!

! Disclaimer: These charts are published for comparative purposes to demonstrate the differences in the series of Combo-Jet® spray tips. Data used to populate this chart is extrapolated from third party testing data from a controlled conditions test with water as the testing solution. Actual spray applications with active chemical ingredients may change the spray dynamics and spray tip performance specifications. Wilger is not liable for any misuse or misrepresentation of this information, leading to (but not limited to) incorrect spray application, crop damage, or any other harm. (Not limited to human, livestock or environmental). Always verify these charts with the most recent charts found on the www.wilger.net, and ALWAYS follow chemical label nozzle requirements.

Nozzle Angle & Sizes	Flow Rate USGPM	Boom Pressure PSI	Application Rate in US Gallons / Acre on 20" Nozzle Spacing @ Sprayer Speed (mph)								Spray Classification, VMD (Droplet Size in μ): %<141μ (Drift %); %<600μ (Small Droplets)															
			Spraying with Auto-Rate Spray System								ER80° Series		SR80° Series		MR80° Series		DR80° Series									
			Application Speed (mph) @								CLASS	VMD	<141	<600	CLASS	VMD	<141	<600	CLASS	VMD	<141	<600	CLASS	VMD	<141	<600
80°-005 Nozzles	Flow us gpm	Boom psi	Application Speed (mph) @								ER80-005 (40270-005)		SR80-005 (40270-005)		MR80-005 (40290-005)		DR80-005 (40280-005)									
			2GPA	3GPA	4GPA	5GPA	6GPA	7GPA	8GPA	CLASS	VMD	<141	<600	CLASS	VMD	<141	<600	CLASS	VMD	<141	<600	CLASS	VMD	<141	<600	
	0.035	20	5.3	3.5	2.6	2.1	1.8	1.5	1.3	F	167	33%	100%													
	0.040	25	5.9	3.9	2.9	2.3	2.0	1.7	1.5	F	157	40%	100%													
	0.043	30	6.4	4.3	3.2	2.6	2.1	1.8	1.6	F	149	46%	100%													
	0.047	35	6.9	4.6	3.5	2.8	2.3	2.0	1.7	F	142	51%	100%													
	0.050	40	7.4	5.0	3.7	3.0	2.5	2.1	1.9	F	137	55%	100%													
	0.053	45	7.9	5.3	3.9	3.2	2.6	2.3	2.0	F	132	59%	100%													
	0.056	50	8.3	5.5	4.2	3.3	2.8	2.4	2.1	F	128	63%	100%													
	0.061	60	9.1	6.1	4.5	3.6	3.0	2.6	2.3	F	121	68%	100%													
	0.064	65	9.5	6.3	4.7	3.8	3.2	2.7	2.4	F	118	71%	100%													
0.066	70	9.8	6.5	4.9	3.9	3.3	2.8	2.5	F	116	73%	100%														
0.071	80	11	7.0	5.3	4.2	3.5	3.0	2.6	VF	111	78%	100%														
80°-0067 Nozzles	Flow us gpm	Boom psi	Application Speed (mph) @								ER80-0067 (40270-007)		SR80-0067 (40270-007)		MR80-0067 (40290-007)		DR80-0067 (40280-007)									
			2GPA	3GPA	4GPA	5GPA	6GPA	7GPA	8GPA	CLASS	VMD	<141	<600	CLASS	VMD	<141	<600	CLASS	VMD	<141	<600	CLASS	VMD	<141	<600	
	0.047	20	7.0	4.7	3.5	2.8	2.3	2.0	1.8	F	199	21%	100%													
	0.053	25	7.9	5.2	3.9	3.1	2.6	2.2	2.0	F	183	29%	100%													
	0.058	30	8.6	5.7	4.3	3.4	2.9	2.5	2.2	F	171	35%	100%													
	0.063	35	9.3	6.2	4.7	3.7	3.1	2.7	2.3	F	161	40%	100%													
	0.067	40	9.9	6.6	5.0	4.0	3.3	2.8	2.5	F	153	45%	100%													
	0.071	45	11	7.0	5.3	4.2	3.5	3.0	2.6	F	147	49%	100%													
	0.075	50	11	7.4	5.6	4.4	3.7	3.2	2.8	F	141	52%	100%													
	0.082	60	12	8.1	6.1	4.9	4.1	3.5	3.0	F	131	58%	100%													
	0.085	65	13	8.5	6.3	5.1	4.2	3.6	3.2	F	128	61%	100%													
0.089	70	13	8.8	6.6	5.3	4.4	3.8	3.3	F	124	63%	100%														
0.095	80	14	9.4	7.0	5.6	4.7	4.0	3.5	F	118	68%	100%														
80°-01 Nozzles	Flow us gpm	Boom psi	Application Speed (mph) @								ER80-01 (40270-01)		SR80-01 (40288-01)		MR80-01 (40290-01)		DR80-01 (40280-01)									
			4GPA	5GPA	6GPA	7.5GPA	8GPA	9GPA	10GPA	CLASS	VMD	<141	<600	CLASS	VMD	<141	<600	CLASS	VMD	<141	<600	CLASS	VMD	<141	<600	
	0.07	20	5.3	4.2	3.5	2.8	2.6	2.3	2.1	F	175	29%	100%	C	292	29%	97%									
	0.08	25	5.9	4.7	3.9	3.1	2.9	2.6	2.3	F	164	35%	100%	M	258	29%	97%									
	0.09	30	6.4	5.1	4.3	3.4	3.2	2.9	2.6	F	156	41%	100%	M	233	29%	97%									
	0.09	35	6.9	5.6	4.6	3.7	3.5	3.1	2.8	F	149	45%	100%	F	214	29%	97%	M	218	23%	97%	C	312	10%	94%	
	0.10	40	7.4	5.9	5.0	4.0	3.7	3.3	3.0	F	143	49%	100%	F	199	29%	97%	F	191	30%	97%	C	291	12%	95%	
	0.11	45	7.9	6.3	5.3	4.2	3.9	3.5	3.2	F	139	53%	100%	F	186	29%	97%	F	181	33%	97%	M	260	15%	97%	
	0.11	50	8.3	6.6	5.5	4.4	4.2	3.7	3.3	F	134	56%	100%	F	176	29%	98%	F	173	36%	97%	M	248	17%	98%	
	0.12	60	9.1	7.3	6.1	4.8	4.5	4.0	3.6	F	128	62%	100%	F	159	29%	98%	F	159	40%	97%	M	229	19%	99%	
	0.13	65	9.5	7.6	6.3	5.0	4.7	4.2	3.8	F	125	64%	100%	F	152	29%	98%	F	153	42%	97%	M	221	20%	100%	
0.13	70	9.8	7.9	6.5	5.2	4.9	4.4	3.9	F	122	66%	100%	F	146	29%	98%	F	148	44%	97%	F	214	21%	101%		
0.14	80	11	8.4	7.0	5.6	5.3	4.7	4.2	F	117	70%	100%	F	135	29%	98%	F	139	48%	97%	F	202	23%	102%		
80°-015 Nozzles	Flow us gpm	Boom psi	Application Speed (mph) @								ER80-015 (40270-015)		SR80-015 (40288-015)		MR80-015 (40290-015)		DR80-015 (40280-015)									
			4GPA	5GPA	6GPA	7.5GPA	8GPA	10GPA	12GPA	CLASS	VMD	<141	<600	CLASS	VMD	<141	<600	CLASS	VMD	<141	<600	CLASS	VMD	<141	<600	
	0.11	20	7.9	6.3	5.3	4.2	3.9	3.2	2.6	F	199	21%	100%													
	0.12	25	8.8	7.0	5.9	4.7	4.4	3.5	2.9	F	188	25%	100%	C	286	13%	94%									
	0.13	30	9.6	7.7	6.4	5.1	4.8	3.9	3.2	F	180	29%	100%	M	262	16%	95%	C	323	10%	94%	VC	418	4%	87%	
	0.14	35	10	8.3	6.9	5.6	5.2	4.2	3.5	F	173	32%	100%	M	244	19%	96%	C	301	12%	95%	VC	397	5%	89%	
	0.15	40	11	8.9	7.4	5.9	5.6	4.5	3.7	F	167	34%	100%	M	230	22%	96%	C	283	14%	96%	C	380	6%	90%	
	0.16	45	12	9.5	7.9	6.3	5.9	4.7	3.9	F	162	37%	100%	M	218	24%	97%	M	269	16%	97%	C	365	6%	91%	
	0.17	50	12	10	8.3	6.6	6.2	5.0	4.2	F	158	39%	100%	F	207	26%	97%	M	256	17%	97%	C	353	7%	92%	
	0.18	60	14	11	9.1	7.3	6.8	5.5	4.5	F	151	42%	100%	F	191	30%	97%	M	236	20%	98%	C	332	8%	94%	
	0.19	65	14	11	9.5	7.6	7.1	5.7	4.7	F	148	44%	100%	F	184	32%	97%	M	227	21%	98%	C	324	8%	94%	
0.20	70	15	12	9.8	7.9	7.4	5.9	4.9	F	145	46%	100%	F	177	33%	98%	M	220	22%	99%	C	316	9%	95%		
0.21	80	16	13	11	8.4	7.9	6.3	5.3	F	140	48%	100%	F	167	36%	98%	F	207	23%	99%	C	302	10%	95%		
80°-02 Nozzles	Flow us gpm	Boom psi	Application Speed (mph) @								ER80-02 (40270-02)		SR80-02 (40288-02)		MR80-02 (40290-02)		DR80-02 (40280-02)									
			5GPA	6GPA	7.5GPA	8GPA	10GPA	12GPA	15GPA	CLASS	VMD	<141	<600	CLASS	VMD	<141	<600	CLASS	VMD	<141	<600	CLASS	VMD	<141	<600	
	0.14	20	8.4	7.0	5.6	5.3	4.2	3.5	2.8	F	184	28%	100%													
	0.16	25	9.4	7.8	6.3	5.9	4.7	3.9	3.1	F	176	31%	100%	C	273	13%	94%									
	0.17	30	10	8.6	6.9	6.4	5.1	4.3	3.4	F	170	34%	100%	M	257	16%	95%	C	326	8%	94%	XC	454	3%	80%	
	0.19	35	11	9.3	7.4	6.9	5.6	4.6	3.7	F	166	36%	100%	M	244	18%	96%	C	310	10%	94%	VC	435	4%	83%	
	0.20	40	12	9.9	7.9	7.4	5.9	5.0	4.0	F	161	38%	100%	M	233	20%	96%	C	298	11%	94%	VC	419	4%	84%	
	0.21	45	13	11	8.4	7.9	6.3																			

COMBO-JET 80° Spray Tips - Standard Sprayer Systems

Nozzle Angle & Sizes	Flow Rate USGPM	Boom Pressure PSI	Application Rate in US Gallons / Acre on 20" Nozzle Spacing								Spray Classification, VMD (Droplet Size in μ); % <141μ (Drift %); % <600μ (Small Droplets)															
			@ Sprayer Speed - Miles / Hour								ER80° Series				SR80° Series				MR80° Series				DR80° Series			
			Application Speed (mph) @								CLASS	VMD	<141	<600	CLASS	VMD	<141	<600	CLASS	VMD	<141	<600	CLASS	VMD	<141	<600
80° -125 Nozzles	Flow	Boom	Application Speed (mph) @								ER80-125 (40270-125)				SR80-125 (40288-125)				MR80-125 (40290-125)				DR80-125 (40280-125)			
	US gpm	psi	20GPA	25GPA	30GPA	35GPA	40GPA	45GPA	50GPA	CLASS	VMD	<141	<600	CLASS	VMD	<141	<600	CLASS	VMD	<141	<600	CLASS	VMD	<141	<600	
	0.99	25	15	12	10	8	7	7	6	XC	433	10%	79%	UC	531	6%	51%	UC	585	5%	56%	UC	624	4%	50%	
	1.08	30	16	13	11	9	8	7	6	XC	413	11%	81%	UC	509	7%	55%	UC	569	6%	58%	UC	609	4%	52%	
	1.17	35	17	14	12	10	9	8	7	VC	397	12%	82%	UC	490	8%	58%	UC	556	6%	60%	UC	595	5%	54%	
	1.25	40	19	15	12	11	9	8	7	VC	383	13%	83%	XC	474	8%	61%	UC	545	7%	62%	UC	584	5%	56%	
	1.33	45	20	16	13	11	10	9	8	C	372	14%	84%	XC	460	9%	63%	UC	535	7%	63%	UC	574	5%	57%	
	1.40	50	21	17	14	12	10	9	8	C	362	14%	85%	XC	447	9%	65%	UC	519	8%	66%	UC	557	6%	59%	
	1.53	60	23	18	15	13	11	10	9	C	345	15%	87%	XC	425	10%	68%	UC	501	8%	67%	UC	549	6%	60%	
	1.65	70	25	20	16	14	12	11	10	C	338	16%	88%	XC	407	11%	70%	UC	505	8%	67%	UC	543	6%	61%	
1.77	80	26	21	18	15	13	12	11	M	320	17%	88%	VC	391	11%	72%	XC	493	9%	69%	UC	531	6%	63%		
80° -15 Nozzles	Flow	Boom	Application Speed (mph) @								ER80-15 (40270-15)				SR80-15 (40288-15)				MR80-15 (40290-15)				DR80-15 (40280-15)			
	US gpm	psi	25GPA	30GPA	35GPA	40GPA	45GPA	50GPA	55GPA	CLASS	VMD	<141	<600	CLASS	VMD	<141	<600	CLASS	VMD	<141	<600	CLASS	VMD	<141	<600	
	1.19	25	14	12	10	9	8	7	6	XC	434	9%	78%	UC	576	5%	43%	UC	513	7%	66%	UC	637	3%	48%	
	1.30	30	15	13	11	10	9	8	7	XC	412	10%	79%	UC	554	6%	47%	UC	495	8%	69%	UC	620	3%	51%	
	1.40	35	17	14	12	10	9	8	8	XC	394	11%	80%	UC	535	6%	51%	UC	480	8%	70%	UC	605	3%	53%	
	1.50	40	18	15	13	11	10	9	8	VC	379	12%	81%	UC	519	6%	53%	UC	467	9%	72%	UC	592	4%	55%	
	1.59	45	19	16	14	12	11	10	9	C	366	13%	82%	UC	505	7%	56%	XC	456	9%	73%	UC	581	4%	57%	
	1.68	50	20	17	14	12	11	10	9	C	355	14%	82%	UC	492	7%	58%	XC	438	10%	75%	UC	562	4%	59%	
	1.84	60	22	18	16	14	12	11	10	C	337	15%	83%	XC	471	7%	61%	XC	430	11%	76%	UC	554	4%	61%	
	1.91	65	23	19	16	14	13	11	10	M	329	16%	84%	XC	461	7%	62%	XC	422	11%	77%	UC	547	4%	62%	
1.98	70	24	20	17	15	13	12	11	M	322	17%	84%	XC	452	8%	63%	XC	410	12%	78%	UC	534	5%	63%		
2.12	80	25	21	18	16	14	13	11	M	310	18%	85%	XC	436	8%	65%	VC	410	12%	78%	UC	534	5%	63%		
80° -20 Nozzles	Flow	Boom	Application Speed (mph) @								ER80-20 (40270-20)				SR80-20 (40288-20)				MR80-20 (40290-20)				DR80-20 (40280-20)			
	US gpm	psi	30GPA	35GPA	40GPA	45GPA	50GPA	55GPA	60GPA	CLASS	VMD	<141	<600	CLASS	VMD	<141	<600	CLASS	VMD	<141	<600	CLASS	VMD	<141	<600	
	1.58	25	16	13	12	10	9	9	8	UC	483	8%	71%	UC	574	5%	44%	UC	564	5%	58%	UC	628	3%	50%	
	1.73	30	17	15	13	11	10	9	9	XC	460	9%	73%	UC	551	5%	48%	UC	542	5%	62%	UC	606	3%	54%	
	1.87	35	19	16	14	12	11	10	9	XC	442	10%	75%	UC	532	6%	51%	UC	523	6%	64%	UC	587	4%	56%	
	2.00	40	20	17	15	13	12	11	10	XC	427	11%	76%	UC	515	6%	54%	UC	508	7%	66%	UC	571	4%	59%	
	2.12	45	21	18	16	14	13	11	11	XC	415	11%	78%	UC	500	6%	56%	UC	494	7%	68%	UC	556	4%	61%	
	2.24	50	22	19	17	15	13	12	11	VC	403	12%	79%	UC	487	7%	58%	UC	472	8%	71%	UC	533	5%	64%	
	2.45	60	24	21	18	16	15	13	12	C	385	13%	81%	XC	464	7%	62%	XC	453	8%	73%	UC	514	5%	66%	
	2.55	65	25	22	19	17	15	14	13	C	377	13%	81%	XC	454	7%	63%	XC	443	8%	74%	UC	498	5%	68%	
2.65	70	26	22	20	17	16	14	13	C	370	14%	82%	XC	444	7%	64%	XC	438	9%	74%	UC	488	5%	68%		
2.83	80	28	24	21	19	17	15	14	C	357	15%	83%	XC	427	8%	66%	XC	428	9%	74%	UC	488	5%	68%		
80° -25 Nozzles	Flow	Boom	Application Speed (mph) @								ER80-25 (40270-25)				SR80-25 (40288-25)				MR80-25 (40290-25)				DR80-25 (40280-25)			
	US gpm	psi	35GPA	40GPA	45GPA	50GPA	55GPA	60GPA	70GPA	CLASS	VMD	<141	<600	CLASS	VMD	<141	<600	CLASS	VMD	<141	<600	CLASS	VMD	<141	<600	
	1.98	25	17	15	13	12	11	10	8	UC	485	9%	70%	UC	532	5%	51%	UC	604	4%	55%	UC	657	3%	46%	
	2.17	30	18	16	14	13	12	11	9	XC	462	10%	72%	UC	511	5%	54%	UC	583	4%	58%	UC	635	3%	49%	
	2.34	35	20	17	15	14	13	12	10	XC	443	10%	74%	UC	494	6%	57%	UC	566	4%	60%	UC	617	3%	52%	
	2.50	40	21	19	17	15	14	12	11	XC	427	11%	75%	UC	479	6%	59%	UC	552	5%	62%	UC	601	3%	55%	
	2.65	45	23	20	18	16	14	13	11	VC	414	12%	76%	UC	466	7%	61%	UC	539	5%	63%	UC	587	3%	57%	
	2.80	50	24	21	18	17	15	14	12	VC	402	12%	77%	XC	454	7%	62%	UC	518	5%	66%	UC	563	4%	60%	
	3.06	60	26	23	20	18	17	15	13	C	383	13%	79%	XC	434	7%	65%	UC	508	6%	67%	UC	553	4%	61%	
	3.19	65	27	24	21	19	17	16	14	C	375	14%	79%	XC	425	8%	66%	UC	500	6%	68%	UC	544	4%	62%	
3.31	70	28	25	22	20	18	16	14	C	367	14%	80%	XC	417	8%	67%	UC	485	6%	69%	UC	528	4%	64%		
3.54	80	30	26	23	21	19	18	15	C	354	15%	81%	XC	402	8%	68%	UC	485	6%	69%	UC	528	4%	64%		
80° -30 Nozzles	Flow	Boom	Application Speed (mph) @								ER80-30 (40270-30)				SR80-30 (40288-30)				MR80-30 (40290-30)				DR80-30 (40280-30)			
	US gpm	psi	40GPA	50GPA	60GPA	70GPA	80GPA	90GPA	100GPA	CLASS	VMD	<141	<600	CLASS	VMD	<141	<600	CLASS	VMD	<141	<600	CLASS	VMD	<141	<600	
	2.37	25	18	14	12	10	9	8	7	UC	506	5%	67%	UC	531	4%	50%	UC	591	4%	55%	UC	654	2%	47%	
	2.60	30	19	15	13	11	10	9	8	UC	481	6%	69%	UC	508	5%	54%	UC	572	4%	58%	UC	623	2%	51%	
	2.81	35	21	17	14	12	10	9	8	XC	461	7%	71%	UC	490	5%	57%	UC	556	4%	60%	UC	597	3%	54%	
	3.00	40	22	18	15	13	11	10	9	XC	444	7%	73%	XC	474	6%	59%	UC	542	5%	62%	UC	575	3%	57%	
	3.18	45	24	19	16	14	12	11	10	XC	430	8%	74%	XC	461	6%	61%	UC	530	5%	64%	UC	556	3%	59%	
	3.35	50	25	20	17	14	12	11	10	XC	417	9%	75%	XC	449	6%	62%	UC	510	5%	67%	UC	525	3%	63%	
	3.67	60	27	22	18	16	14	12	11	XC	397	9%	77%	XC	429	6%	65%	UC	503	5%	68%	UC	512	3%	65%	
	3.82	65	28	23	19	16	14	13	11	XC	388	10%	77%	XC	421	7%	66%	UC	491	6%	69%	UC	500	4%	66%	
3.97	70	29	24	20	17	15	13	12	VC	380	10%	78%	XC	414	7%	67%	UC	480	6%	71%	XC	479	4%	68%		
4.24	80	32																								

COMBO-JET 110° Spray Tips - Standard Sprayer Systems

Comprehensive rate & speed charts for any nozzle spacing/speed/rate is available on Tip Wizard. Try it today!

⚠ Disclaimer: These charts are published for comparative purposes to demonstrate the differences in the series of Combo-Jet® spray tips. Data used to populate this chart is extrapolated from third party testing data from a controlled conditions test with water as the testing solution. Actual spray applications with active chemical ingredients may change the spray dynamics and spray tip performance specifications. Wilger is not liable for any misuse or misrepresentation of this information, leading to (but not limited to) incorrect spray application, crop damage, or any other harm. (Not limited to human, livestock or environmental). Always verify these charts with the most recent charts found on the www.wilger.net, and ALWAYS follow chemical label nozzle requirements.

<p>ASABE Spray Classification (ASABE S572.1 Standard) Spray quality is categorized based on Dv0.1 and VMD droplet sizes. Objective testing data (by 3rd party), from spray spectrum recording equipment (without wind tunnel use), has been used to classify spray quality for this chart. Extra data (e.g. VMD, etc.) can vary between testing equipment and method, and is provided as an educational resource only. <small>Tips sized up to 110-06 verified on Phase Doppler Particle Analyzer (PDPA); tips sized over 110-06 verified on Malvern.</small></p>	<p> ■ Fine (F) ■ Medium (M) ■ Coarse (C) ■ Very Coarse (VC) ■ Extremely Coarse (XC) ■ Ultra Coarse (UC) </p>	<p>VMD (Volume Median Diameter) The median droplet (in μ) for a sprayed volume. Half of the volume is made of droplets smaller, with half made up of droplets larger.</p>	<p>% <141μ (% Driftable Fines) Percentage of volume which is likely to drift. As wind & boom height increase, observed spray drift will increase substantially.</p>	<p>% <600μ (% of Small Droplets) % of volume which is made up of 'small' droplets, useful for coverage. As % of useful droplets lowers, overall coverage is reduced.</p>
---------------------------------------------------------------------------------------------------------------------------------------------------------------------------------------------------------------------------------------------------------------------------------------------------------------------------------------------------------------------------------------------------------------------------------------------------------------------------------------------------------------------------------------------------------------------------------------------------------	----------------------------------------------------------------------------------------------------------------------------------------------------------------------------------------------------------------------------------------------------------------------------------------------------------------------------------------------------------------	-----------------------------------------------------------------------------------------------------------------------------------------------------------------------------------------------	------------------------------------------------------------------------------------------------------------------------------------------------------------------------------------------------	-------------------------------------------------------------------------------------------------------------------------------------------------------------------------------------------------

Nozzle Angle & Sizes	Flow Rate USGPM	Boom Pressure PSI	Application Rate in US Gallons / Acre on 20" Nozzle Spacing										Spray Classification, VMD (Droplet Size in μ); %<141μ (Drift %); %<600μ (Small Droplets)																										
			@ Sprayer Speed - Miles / Hour										ER110° Series				SR110° Series				MR110° Series				DR110° Series				UR Series										
			Application Speed (mph) @										ER110-01 (40281-01)		ER110-01 (40281-01)		SR110-01 (40287-01)		SR110-01 (40287-01)		MR110-01 (40291-01)		MR110-01 (40291-01)		DR110-01 (40286-01)		DR110-01 (40286-01)		CLASS	VMD									
110° -01 Nozzles	Flow us gpm	Boom psi	4GPA	5GPA	6GPA	7.5GPA	8GPA	9GPA	10GPA	12GPA	15GPA	CLASS	VMD	<141	<600	CLASS	VMD	<141	<600	CLASS	VMD	<141	<600	CLASS	VMD	<141	<600	CLASS	VMD	<141	<600	CLASS	VMD						
	0.07	20	5.3	4.2	3.5	2.8	2.6	2.3	2.1	F	148	45%	100%	F	148	45%	100%	F	148	45%	100%	F	148	45%	100%	F	148	45%	100%	F	148	45%	100%	F	148	45%	100%		
	110° -015 Nozzles	Flow us gpm	Boom psi	4GPA	5GPA	6GPA	7.5GPA	8GPA	9GPA	10GPA	12GPA	15GPA	CLASS	VMD	<141	<600	CLASS	VMD	<141	<600	CLASS	VMD	<141	<600	CLASS	VMD	<141	<600	CLASS	VMD	<141	<600	CLASS	VMD	<141	<600	CLASS	VMD	
		0.11	20	7.9	6.3	5.3	4.2	3.9	3.2	2.6	F	153	40%	100%	F	153	40%	100%	M	225	21%	98%					C	322	11%	94%	C	366	7%	92%					
		110° -02 Nozzles	Flow us gpm	Boom psi	5GPA	6GPA	7.5GPA	8GPA	10GPA	12GPA	15GPA	CLASS	VMD	<141	<600	CLASS	VMD	<141	<600	CLASS	VMD	<141	<600	CLASS	VMD	<141	<600	CLASS	VMD	<141	<600	CLASS	VMD	<141	<600	CLASS	VMD		
			0.14	20	8.4	7.0	5.6	5.3	4.2	3.5	2.8	F	173	32%	100%	M	227	21%	99%					C	315	12%	95%	VC	431	5%	82%								
			110° -025 Nozzles	Flow us gpm	Boom psi	5GPA	6GPA	7.5GPA	8GPA	10GPA	12GPA	15GPA	CLASS	VMD	<141	<600	CLASS	VMD	<141	<600	CLASS	VMD	<141	<600	CLASS	VMD	<141	<600	CLASS	VMD	<141	<600	CLASS	VMD	<141	<600	CLASS	VMD	
				0.18	20	11	8.8	7.0	6.6	5.3	4.4	3.5	F	194	28%	100%	M	244	18%	98%					C	350	9%	91%	VC	434	5%	80%							
				110° -03 Nozzles	Flow us gpm	Boom psi	5GPA	6GPA	7.5GPA	8GPA	10GPA	12GPA	15GPA	CLASS	VMD	<141	<600	CLASS	VMD	<141	<600	CLASS	VMD	<141	<600	CLASS	VMD	<141	<600	CLASS	VMD	<141	<600	CLASS	VMD	<141	<600	CLASS	VMD
					0.21	20	13	11	8.4	7.9	6.3	5.3	4.2	F	198	27%	99%	C	319	9%	94%	VC	394	6%	86%	XC	479	4%	74%										

NOTE: 'SR, MR, DR, UR spray tips include pre-orifices). Pre-orifices are not interchangeable between different spray tips of different series. *Shown application information is based on water @ 80°F in a controlled environment and should not be considered actual. Information is provided for comparison to other Combo-Jet® spray tips, for educational purposes only. Repeat testing results can vary.

COMBO-JET 110° Spray Tips - Standard Sprayer Systems

NOZZLES

Disclaimer: These charts are published for comparative purposes to demonstrate the differences in the series of Combo-Jet® spray tips. Data used to populate this chart is extrapolated from third party testing data from a controlled conditions test with water as the testing solution. Actual spray applications with active chemical ingredients may change the spray dynamics and spray tip performance specifications. Wilger is not liable for any misuse or misrepresentation of this information, leading to (but not limited to) incorrect spray application, crop damage, or any other harm. (Not limited to human, livestock or environmental). Always verify these charts with the most recent charts found on the www.wilger.net, and ALWAYS follow chemical label nozzle requirements.

ASABE Spray Classification (ASABE S572.1 Standard) Spray quality is categorized based on Dv0.1 and VMD droplet sizes. Objective testing data (by 3rd party), from spray spectrum recording equipment (without wind tunnel use), has been used to classify spray quality for this chart. Extra data (e.g. VMD, etc.) can vary between testing equipment and method, and is provided as an educational resource only. Tips sized up to 110-06 verified on Phase Doppler Particle Analyzer (PDPA); tips sized over 110-06 verified on Malvern.		Fine (F) Medium (M) Coarse (C) Very Coarse (VC) Extremely Coarse (XC) Ultra Coarse (UC)	VMD (Volume Median Diameter) The median droplet (in μ) for a sprayed volume. Half of the volume is made of droplets smaller, with half made up of droplets larger.	% <141μ (% Driftable Finest) Percentage of volume which is likely to drift. As wind & boom height increase, observed spray drift will increase substantially.	% <600μ (% of Small Droplets) % of volume which is made up of 'small' droplets, useful for coverage. As % of useful droplets lowers, overall coverage is reduced.
-------------------------------------------------------------------------------------------------------------------------------------------------------------------------------------------------------------------------------------------------------------------------------------------------------------------------------------------------------------------------------------------------------------------------------------------------------------------------------------------------------------------------------------------------------------	--	--------------------------------------------------------------------------------------------------------	------------------------------------------------------------------------------------------------------------------------------------------------------------------------------	----------------------------------------------------------------------------------------------------------------------------------------------------------------------------	--------------------------------------------------------------------------------------------------------------------------------------------------------------------------------

Nozzle Angle & Sizes	Flow Rate USGPM	Boom Pressure PSI	Application Rate in US Gallons / Acre on 20" Nozzle Spacing										Spray Classification, VMD (Droplet Size in μ); %<141μ (Drift %); %<600μ (Small Droplets)																							
			@ Sprayer Speed - Miles / Hour										ER110° Series				SR110° Series				MR110° Series				DR110° Series				UR Series							
			8GPA	10GPA	12.5GPA	15GPA	18GPA	20GPA	25GPA	30GPA	35GPA	40GPA	CLASS	VMD	<141	<600	CLASS	VMD	<141	<600	CLASS	VMD	<141	<600	CLASS	VMD	<141	<600	CLASS	VMD	<141	<600				
110° -04 Nozzles	Flow us.gpm	Boom psi	Application Speed (mph) @										ER110-04 (40281-04)				SR110-04 (40287-04)				MR110-04 (40291-04)				DR110-04 (40286-04)				UR110-04 (40292-04)							
	0.28	20	11	8	6.7	5.6	4.2	3.4	2.8	2.8	M	240	18%	97%	C	330	9%	93%	VC	416	5%	84%	XC	510	3%	69%	UC	621								
	110° -05 Nozzles	Flow us.gpm	Boom psi	Application Speed (mph) @										ER110-05 (40281-05)				SR110-05 (40287-05)				MR110-05 (40291-05)				DR110-05 (40286-05)				UR110-05 (40292-05)						
		0.35	20	11	8	7	5.8	5.3	4.2	3.5	M	248	18%	95%	C	377	7%	89%	VC	486	3%	72%	XC	530	2%	63%	UC	638								
		110° -06 Nozzles	Flow us.gpm	Boom psi	Application Speed (mph) @										ER110-06 (40281-06)				SR110-06 (40287-06)				MR110-06 (40291-06)				DR110-06 (40286-06)				UR110-06 (40292-06)					
			0.42	20	13	10	8	7	6.3	4.2	3.6	C	282	14%	94%	VC	444	4%	80%	XC	507	3%	68%	XC	565	2%	57%	UC	652							
			110° -08 Nozzles	Flow us.gpm	Boom psi	Application Speed (mph) @										ER110-08 (40281-08)				SR110-08 (40287-08)				MR110-08 (40291-08)				DR110-08 (40286-08)				UR110-08 (40292-08)				
				0.57	20	11	9	8	7	6	4.8	4.2	C	327	14%	91%	UC	481	5%	61%	UC	531	4%	53%	UC	614	3%	40%	UC	675						
				110° -10 Nozzles	Flow us.gpm	Boom psi	Application Speed (mph) @										ER110-10 (40281-10)				SR110-10 (40287-10)				MR110-10 (40291-10)				DR110-10 (40286-10)				UR110-10 (40292-10)			
					0.71	20	14	12	11	8	7	5	4	VC	362	10%	88%	UC	500	5%	56%	UC	523	4%	53%	UC	609	5%	59%	UC	682					
					110° -125 Nozzles	Flow us.gpm	Boom psi	Application Speed (mph) @										ER110-125 (40281-125)				SR110-125 (40287-125)				MR110-125 (40291-125)				DR110-125 (40286-125)				UR110-125 (40292-125)		
0.99						25	15	12	10	8	7	6	5	XC	421	9%	70%	UC	538	4%	48%	UC	647	4%	34%	UC	667	3%	32%	UC	735					

COMBO-JET 110° Spray Tips - Standard Sprayer Systems

Comprehensive rate & speed charts for any nozzle spacing/speed/rate is available on Tip Wizard. Try it today!

! Disclaimer: These charts are published for comparative purposes to demonstrate the differences in the series of Combo-Jet® spray tips. Data used to populate this chart is extrapolated from third party testing data from a controlled conditions test with water as the testing solution. Actual spray applications with active chemical ingredients may change the spray dynamics and spray tip performance specifications. Wilger is not liable for any misuse or misrepresentation of this information, leading to (but not limited to) incorrect spray application, crop damage, or any other harm. (Not limited to human, livestock or environmental). Always verify these charts with the most recent charts found on the www.wilger.net, and ALWAYS follow chemical label nozzle requirements.

Nozzle Angle & Sizes	Flow Rate USGPM	Boom Pressure PSI	Application Rate in US Gallons / Acre on 20" Nozzle Spacing										Spray Classification, VMD (Droplet Size in μ); %<141 μ (Drift %); %<600 μ (Small Droplets)													
			@ Sprayer Speed - Miles / Hour										ER110° Series			SR110° Series			MR110° Series			DR110° Series				
			Flow US gpm	Boom psi	25GPA	30GPA	35GPA	40GPA	45GPA	50GPA	55GPA	60GPA	CLASS	VMD	<141	<600	CLASS	VMD	<141	<600	CLASS	VMD	<141	<600	CLASS	VMD
110° -15 Nozzles	1.19	25	14	12	10	9	8	7	6	XC	416	10%	68%	UC	565	4%	45%									
	1.30	30	15	13	11	10	9	8	7	XC	398	10%	72%	UC	538	5%	51%									
	1.40	35	17	14	12	10	9	8	8	XC	383	11%	74%	UC	515	5%	55%	UC	590	4%	43%	UC	641	4%	43%	
	1.50	40	18	15	13	11	10	9	8	VC	370	12%	76%	UC	496	6%	58%	UC	574	4%	45%	UC	624	4%	46%	
	1.59	45	19	16	14	12	11	10	9	VC	358	12%	77%	XC	478	6%	61%	UC	560	5%	47%	UC	610	4%	48%	
	1.68	50	20	17	14	12	11	10	9	C	348	13%	79%	XC	463	6%	64%	UC	548	5%	49%	UC	597	4%	50%	
	1.84	60	22	18	16	14	12	11	10	C	330	14%	81%	XC	436	7%	67%	UC	527	5%	52%	UC	575	4%	53%	
	1.91	65	23	19	16	14	13	11	10	C	322	14%	82%	XC	424	7%	69%	UC	517	5%	53%	UC	565	4%	54%	
	1.98	70	24	20	17	15	13	12	11	C	315	15%	82%	XC	413	7%	70%	UC	508	5%	54%	UC	556	4%	55%	
	2.12	80	25	21	18	16	14	13	11	C	302	15%	84%	XC	393	8%	72%	UC	493	5%	56%	UC	540	5%	58%	
110° -20 Nozzles	1.58	25	16	13	12	10	9	8	XC	473	7%	60%														
	1.73	30	17	15	13	11	10	9	9	XC	453	8%	64%													
	1.87	35	19	16	14	12	11	10	9	XC	437	8%	66%	UC	497	6%	59%	UC	574	5%	45%					
	2.00	40	20	17	15	13	12	11	10	XC	422	9%	68%	XC	479	6%	62%	UC	557	5%	48%					
	2.12	45	21	18	16	14	13	11	11	XC	410	9%	70%	XC	463	7%	65%	UC	542	5%	50%					
	2.24	50	22	19	17	15	13	12	11	XC	399	9%	72%	XC	449	7%	67%	UC	529	6%	52%					
	2.45	60	24	21	18	16	15	13	12	XC	379	10%	74%	XC	424	8%	70%	UC	506	6%	55%					
	2.55	65	25	22	19	17	15	14	13	VC	370	10%	75%	XC	413	8%	72%	UC	496	6%	56%					
	2.65	70	26	22	20	17	16	14	13	VC	362	10%	76%	XC	403	8%	73%	UC	487	6%	57%					
	2.83	80	28	24	21	19	17	15	14	C	348	11%	78%	XC	385	8%	75%	XC	470	7%	59%					
110° -25 Nozzles	1.98	25	17	15	13	12	11	10	8	XC	472	7%	60%													
	2.17	30	18	16	14	13	12	11	9	XC	453	7%	65%													
	2.34	35	20	17	15	14	13	12	10	XC	437	7%	68%	UC	484	6%	59%									
	2.50	40	21	19	17	15	14	12	11	XC	422	7%	71%	XC	468	6%	62%									
	2.65	45	23	20	18	16	14	13	11	XC	410	8%	73%	XC	453	7%	64%									
	2.80	50	24	21	18	17	15	14	12	XC	399	8%	74%	XC	441	7%	66%									
	3.06	60	26	23	20	18	17	15	13	XC	380	8%	77%	XC	419	8%	69%									
	3.19	65	27	24	21	19	17	16	14	VC	371	8%	78%	XC	409	8%	70%									
	3.31	70	28	25	22	20	18	16	14	VC	364	8%	79%	XC	400	8%	71%									
	3.54	80	30	26	23	21	19	18	15	C	350	8%	81%	XC	384	8%	73%									
110° -30 Nozzles	2.37	25	18	14	12	10	9	8	7	UC	484	6%	58%													
	2.60	30	19	15	13	11	10	9	8	XC	466	6%	61%													
	2.81	35	21	17	14	12	10	9	8	XC	451	7%	63%													
	3.00	40	22	18	15	13	11	10	9	XC	437	7%	65%													
	3.18	45	24	19	16	14	12	11	10	XC	425	8%	67%													
	3.35	50	25	20	17	14	12	11	10	XC	415	8%	68%													
	3.67	60	27	22	18	16	14	12	11	XC	396	9%	70%													
	3.82	65	28	23	19	16	14	13	11	XC	388	9%	71%													
	3.97	70	29	24	20	17	15	13	12	XC	381	9%	72%													
	4.24	80	32	25	21	18	16	14	13	VC	367	9%	73%													

COMBO-JET 80° Spray Tips - PWM Spray Systems

Comprehensive rate & speed charts for any nozzle spacing/speed/rate is available on Tip Wizard. Try it today!

⚠ Disclaimer: These charts are published for comparative purposes to demonstrate the differences in the series of Combo-Jet® spray tips. Data used to populate this chart is extrapolated from third party testing data from a controlled conditions test with water as the testing solution. Actual spray applications with active chemical ingredients may change the spray dynamics and spray tip performance specifications. Wilger is not liable for any misuse or misrepresentation of this information, leading to (but not limited to) incorrect spray application, crop damage, or any other harm. (Not limited to human, livestock or environmental). Always verify these charts with the most recent charts found on the www.wilger.net, and ALWAYS follow chemical label nozzle requirements.

ASABE Spray Classification (ASABE S572.1 Standard) Spray quality is categorized based on Dv0.1 and VMD droplet sizes. Objective testing data (by 3rd party), from spray spectrum recording equipment (without wind tunnel use), has been used to classify spray quality for this chart. Extra data (e.g. VMD, etc.) can vary between testing equipment and method, and is provided as an educational resource only. <small>Tips sized up to 110-06 verified on Phase Doppler Particle Analyzer (PDPA); tips sized over 110-06 verified on Malvern.</small>	Fine (F) Medium (M) Coarse (C) Very Coarse (VC) Extremely Coarse (XC) Ultra Coarse (UC)	VMD (Volume Median Diameter) The median droplet (in μ) for a sprayed volume. Half of the volume is made of droplets smaller, with half made up of droplets larger.	% <141μ (% Driftable Fines) Percentage of volume which is likely to drift. As wind & boom height increase, observed spray drift will increase substantially.	% <600μ (% of Small Droplets) % of volume which is made up of 'small' droplets, useful for coverage. As % of useful droplets lowers, overall coverage is reduced.
----------------------------------------------------------------------------------------------------------------------------------------------------------------------------------------------------------------------------------------------------------------------------------------------------------------------------------------------------------------------------------------------------------------------------------------------------------------------------------------------------------------------------------------------------------------------------	--------------------------------------------------------------------------------------------------------	-----------------------------------------------------------------------------------------------------------------------------------------------------------------------------------	------------------------------------------------------------------------------------------------------------------------------------------------------------------------------------------	-----------------------------------------------------------------------------------------------------------------------------------------------------------------------------------------------

Nozzle Angle & Sizes	Flow Rate USGPM	Boom Pressure PSI	Tip PSI	Application Rate - US Gallons/Acre on 20" Spacing w/ PWM Sprayer System					Spray Classification, VMD (Droplet Size in μ): %<141 μ (Drift Fines); %<600 μ (Small Droplets)															
				Application Speed (mph) @ 25-100% Duty Cycle					ER80° Series		SR80° Series		MR80° Series		DR80° Series									
				2gpa	3gpa	4gpa	5gpa	Duty Cycle	Class	VMD	Class	VMD	Class	VMD	Class	VMD	Class	VMD	Class	VMD				
80-005 Nozzles	Flow us gpm	Boom psi	Tip psi	Application Speed (mph) @ 25-100% Duty Cycle					ER80-005 (40270-005)															
	20	20	20	1.3-5.3	0.9-3.5	0.7-2.6	0.5-2.1	F	167	33%	100%													
	0.04	25	25	1.5-5.9	1-3.9	0.7-2.9	0.6-2.3	F	157	40%	100%		M	261	11%	99%	C	311	6%	100%				
	0.04	30	30	1.6-6.4	1.1-4.3	0.8-3.2	0.7-2.6	F	149	46%	100%		M	236	17%	98%	C	276	11%	100%				
	0.05	35	35	1.7-6.9	1.2-4.6	0.9-3.5	0.7-2.8	F	142	51%	100%		M	217	22%	97%	M	250	16%	100%				
	0.05	40	40	1.9-7.4	1.3-5	0.9-3.7	0.8-3	F	137	55%	100%		F	201	26%	96%	M	230	19%	100%				
	0.05	45	45	2-7.9	1.3-5.3	1-3.9	0.8-3.2	F	132	59%	100%		F	189	30%	95%	F	213	23%	100%				
	0.06	50	50	2.1-8.3	1.4-5.5	1.1-4.2	0.8-3.3	F	128	63%	100%		F	178	33%	94%	F	200	25%	100%				
	0.06	60	60	2.3-9.1	1.5-6.1	1.1-4.5	0.9-3.6	F	121	68%	100%		F	161	39%	93%	F	178	30%	100%				
	0.06	65	65	2.4-9.5	1.6-6.3	1.2-4.7	1-3.8	F	118	71%	100%		F	154	41%	92%	F	169	33%	100%				
0.07	70	70	2.5-9.8	1.6-6.5	1.2-4.9	1-3.9	F	116	73%	100%		F	148	44%	91%	F	161	35%	100%					
0.07	80	80	2.8-11	1.8-7	1.3-5.3	1.1-4.2	F	111	78%	100%		F	138	48%	90%	F	148	38%	100%					
80-0067 Nozzles	Flow us gpm	Boom psi	Tip psi	Application Speed (mph) @ 25-100% Duty Cycle					ER80-0067 (40270-0067)															
	0.05	20	20	1.8-7	1.2-4.7	0.9-3.5	0.7-2.8	F	199	21%	100%													
	0.05	25	25	2-7.9	1.3-5.2	1-3.9	0.8-3.1	F	183	29%	100%		M	231	18%	99%	C	337	6%	100%				
	0.06	30	30	2.2-8.6	1.4-5.7	1.1-4.3	0.9-3.4	F	171	35%	100%		F	211	24%	98%	C	308	9%	100%				
	0.06	35	35	2.3-9.3	1.6-6.2	1.2-4.7	0.9-3.7	F	161	40%	100%		F	195	29%	97%	C	285	11%	100%				
	0.07	40	40	2.5-9.9	1.7-6.6	1.3-5	1-4	F	153	45%	100%		F	182	33%	96%	M	267	13%	100%				
	0.07	45	45	2.8-11	1.8-7	1.3-5.3	1.1-4.2	F	147	49%	100%		F	171	37%	95%	M	252	15%	100%				
	0.07	50	50	2.8-11	1.9-7.4	1.4-5.6	1.1-4.4	F	141	52%	100%		F	162	40%	94%	M	239	17%	100%				
	0.08	60	60	3-12	2-8.1	1.5-6.1	1.2-4.9	F	131	58%	100%		F	148	46%	93%	M	218	20%	100%				
	0.09	65	65	3.3-13	2.1-8.5	1.6-6.3	1.3-5.1	F	128	61%	100%		F	142	49%	92%	F	210	21%	100%				
0.09	70	70	3.3-13	2.2-8.8	1.7-6.6	1.3-5.3	F	124	63%	100%		F	136	51%	91%	F	202	22%	100%					
0.09	80	80	3.5-14	2.4-9.4	1.8-7	1.4-5.6	F	118	68%	100%		F	127	55%	90%	F	189	24%	100%					
80-01 Nozzles	Flow us gpm	Boom psi	Tip psi	Application Speed (mph) @ 25-100% Duty Cycle					ER80-01 (40270-01)	SR80-01 (40288-01)	MR80-01 (40290-01)	DR80-01 (40280-01)												
	0.07	20	20	2.8-11	1.8-7	1.3-5.3	1.1-4.2	F	176	28%	100%													
	0.08	25	25	3-12	2-7.8	1.5-5.9	1.2-4.7	F	165	35%	100%	M	259	29%	97%									
	0.09	30	30	3.3-13	2.2-8.6	1.6-6.4	1.3-5.1	F	156	41%	100%	M	234	29%	97%	M	219	23%	97%	C	312	10%	94%	
	0.09	35	35	3.5-14	2.3-9.3	1.7-6.9	1.4-5.6	F	149	45%	100%	F	215	29%	97%	F	204	27%	97%	C	292	12%	95%	
	0.10	40	40	3.8-15	2.5-9.9	1.9-7.4	1.5-5.9	F	144	49%	100%	F	199	29%	97%	F	192	30%	97%	C	275	14%	96%	
	0.11	45	45	4-16	2.8-11	2-7.9	1.6-6.3	F	139	53%	100%	F	187	29%	97%	F	182	33%	97%	M	261	15%	97%	
	0.11	50	50	4.3-17	2.8-11	2.1-8.3	1.7-6.6	F	135	56%	100%	F	176	29%	98%	F	173	36%	97%	M	249	17%	98%	
	0.12	60	60	4.5-18	3-12	2.3-9.1	1.8-7.3	F	128	61%	100%	F	159	29%	98%	F	159	40%	97%	M	230	19%	99%	
	0.13	65	65	4.8-19	3.3-13	2.4-9.5	1.9-7.6	F	125	64%	100%	F	152	29%	98%	F	153	42%	97%	M	221	20%	100%	
0.13	70	70	5-20	3.3-13	2.5-9.8	2-7.9	F	122	66%	100%	F	146	29%	98%	F	148	44%	97%	F	214	21%	101%		
0.14	80	80	5.3-21	3.5-14	2.8-11	2.1-8.4	F	117	70%	100%	F	135	29%	98%	F	139	48%	97%	F	202	23%	102%		
80-015 Nozzles	Flow us gpm	Boom psi	Tip psi	Application Speed (mph) @ 25-100% Duty Cycle					ER80-015 (40270-015)	SR80-015 (40288-015)	MR80-015 (40290-015)	DR80-015 (40280-015)												
	0.11	20	20	2.5-10	2.5-10	1.6-6.3	1.3-5.2	F	200	21%	100%													
	0.12	25	25	3-12	2.2-8.8	1.8-7	1.5-5.8	F	189	25%	100%	C	287	12%	94%									
	0.13	30	30	3.3-13	2.4-9.6	1.9-7.7	1.6-6.4	F	180	29%	100%	M	264	16%	95%	C	324	10%	94%	VC	419	4%	87%	
	0.14	35	35	3.5-14	2.5-10	2.1-8.3	1.7-6.9	F	173	32%	100%	M	245	19%	96%	C	302	12%	95%	VC	398	5%	89%	
	0.15	40	40	3.8-15	2.8-11	2.2-8.9	1.9-7.4	F	167	34%	100%	M	231	22%	96%	C	285	14%	96%	C	381	6%	90%	
	0.16	45	45	4-16	3-12	2.4-9.4	2-7.8	F	162	37%	100%	M	219	24%	97%	M	270	16%	97%	C	367	6%	91%	
	0.17	50	50	4.3-17	3-12	2.5-9.9	2.1-8.3	F	158	39%	100%	F	208	26%	97%	M	257	17%	97%	C	354	7%	92%	
	0.18	60	60	4.5-18	3.5-14	2.8-11	2.3-9.1	F	151	42%	100%	F	191	30%	97%	M	237	19%	98%	C	333	8%	94%	
	0.19	65	65	4.8-19	3.5-14	2.8-11	2.4-9.4	F	148	44%	100%	F	184	31%	97%	M	228	21%	98%	C	325	8%	94%	
0.20	70	70	5-20	3.8-15	3-12	2.5-9.8	F	145	45%	100%	F	178	33%	98%	M	221	22%	99%	C	317	9%	95%		
0.21	80	80	5.3-21	4-16	3.3-13	2.5-10	F	140	48%	100%	F	168	35%	98%	F	208	23%	99%	C	303	10%	95%		
80-02 Nozzles	Flow us gpm	Boom psi	Tip psi	Application Speed (mph) @ 25-100% Duty Cycle					ER80-02 (40270-02)	SR80-02 (40288-02)	MR80-02 (40290-02)	DR80-02 (40280-02)												
	0.14	20	20	3.5-14	2.5-10	2.1-8.3	1.7-6.9	F	185	28%	100%													
	0.16	25	25	4-16	3-12	2.3-9.3	2-7.8	F	177	31%	100%	C	275	12%	94%									
	0.17	30	30	4.3-17	3.3-13	2.5-10	2.1-8.5	F	171	34%	100%	M	258	15%	95%	C	328	8%	94%	XC	456	3%	80%	
	0.19	35	35	4.5-18	3.5-14	2.8-11	2.3-9.2	F	166	36%	100%	M	245	18%	96%	C	312	10%	94%	VC	437	4%	82%	
	0.20	40	40	5-20	3.8-15	3-12	2.5-9.8	F	162	38%	100%	M	235	20%	96%	C	299	11%	94%	VC	421	4%	84%	
	0.21	45	45	5.3-21	4-16	3-12	2.5-10	F	158	40%	100%	M	225	22%	97%	C	288	12%	94%	VC	408	5%	85%	
	0.22	50	50	5.5-22	4-16	3.3-13	2.8-11	F	155	42%	100%	M	217	24%	97%	C	279	13%	95%	VC	396	5%	86%	
	0.24	60	60	6-24	4.5-18	3.5-14	3-12	F	150	44%	100%	F	204	27%	98%	M	263	15%	95%	C	376	6%	88%	
	0.25	65	65	6.3-25	4.8-19	3.8-15	3.3-13	F	148	45%	100%	F	199	28%	98%	M	257	16%	95%	C	368	6%	89%	
0.26	70	70	6.5-26	4.8-19	4-16	3.3-13	F	146	47%	99%	F	194	29%	98%	M	251	17%	95%	C	361	7%	89%		
0.28	80	80	7-28	5.3-21	4.3-17	3.5-14	F	142	49%	99%	F	186	32%	98%	M	240	19%</							

COMBO-JET 80° Spray Tips - PWM Spray Systems

Table with columns for Nozzle Angle & Sizes, Flow Rate USGPM, Boom Pressure PSI, Tip PSI, Application Rate - US Gallons/Acre on 20" Spacing w/ PWM Sprayer System, Spray Classification, VMD (Droplet Size in μ), and various series (ER80, SR80, MR80, DR80) with Class and VMD values.

NOTE: 'SR, MR, DR, UR spray tips include pre-orifice(s). Pre-orifices are not interchangeable between different spray tips of different series. *Shown application information is based on water @ 80°F in a controlled environment and should not be considered actual. Information is provided for comparison to other Combo-Jet® spray tips, for educational purposes only. Repeat testing results can vary.

COMBO-JET 80° Spray Tips - PWM Spray Systems

NONZEFES

PWM SPRAY CHARTS

Comprehensive rate & speed charts for any nozzle spacing/speed/rate is available on Tip Wizard. Try it today!

! Disclaimer: These charts are published for comparative purposes to demonstrate the differences in the series of Combo-Jet® spray tips. Data used to populate this chart is extrapolated from third party testing data from a controlled conditions test with water as the testing solution. Actual spray applications with active chemical ingredients may change the spray dynamics and spray tip performance specifications. Wilger is not liable for any misuse or misrepresentation of this information, leading to (but not limited to) incorrect spray application, crop damage, or any other harm. (Not limited to human, livestock or environmental). Always verify these charts with the most recent charts found on the www.wilger.net, and ALWAYS follow chemical label nozzle requirements.

<p>ASABE Spray Classification (ASABE S572.1 Standard)</p> <p>Spray quality is categorized based on D_{v0.1} and VMD droplet sizes. Objective testing data (by 3rd party), from spray spectrum recording equipment (without wind tunnel use), has been used to classify spray quality for this chart. Extra data (e.g. VMD, etc.) can vary between testing equipment and method, and is provided as an educational resource only.</p> <p><small>Tips sized up to 110-06 verified on Phase Doppler Particle Analyzer (PDPA); tips sized over 110-06 verified on Malvern</small></p>	<ul style="list-style-type: none"> ■ Fine (F) ■ Medium (M) ■ Coarse (C) ■ Very Coarse (VC) ■ Extremely Coarse (XC) ■ Ultra Coarse (UC) 	<p>VMD (Volume Median Diameter)</p> <p>The median droplet (in μ) for a sprayed volume. Half of the volume is made of droplets smaller, with half made up of droplets larger.</p>	<p>% <141μ (% Driftable Fines)</p> <p>Percentage of volume which is likely to drift. As wind & boom height increase, observed spray drift will increase substantially.</p>	<p>% <600μ (% of Small Droplets)</p> <p>% of volume which is made up of 'small' droplets, useful for coverage. As % of useful droplets lowers, overall coverage is reduced.</p>
--------------------------------------------------------------------------------------------------------------------------------------------------------------------------------------------------------------------------------------------------------------------------------------------------------------------------------------------------------------------------------------------------------------------------------------------------------------------------------------------------------------------------------------------------------------------------------------------------	----------------------------------------------------------------------------------------------------------------------------------------------------------------------------------------------------------------------------------------------------------------------------------------------------------------------------------------------------------------------------------------------------------------------	--------------------------------------------------------------------------------------------------------------------------------------------------------------------------------------------------------	---------------------------------------------------------------------------------------------------------------------------------------------------------------------------------------------------------	----------------------------------------------------------------------------------------------------------------------------------------------------------------------------------------------------------

Nozzle Angle & Sizes	Flow Rate USGPM	Boom Pressure PSI	Tip PSI	Application Rate - US Gallons/Acre on 20" Spacing w/ PWM Sprayer System				Spray Classification, VMD (Droplet Size in μ); %<141 μ (Drift %); %<600 μ (Small Droplets)															
				Application Speed (mph) @ 25-100% Duty Cycle				ER80° Series				SR80° Series				MR80° Series				DR80° Series			
				15gpa	18gpa	20gpa	25gpa	Class	VMD	<141	<600	Class	VMD	<141	<600	Class	VMD	<141	<600	Class	VMD	<141	<600
80-125 Nozzles	Flow us gpm	Boom psi	Tip psi	Application Speed (mph) @ 25-100% Duty Cycle				ER80-125 (40270-125)				SR80-125 (40288-125)				MR80-125 (40290-125)				DR80-125 (40280-125)			
	0.91	35	21	4.5-18	3.8-15	3.5-14	2.8-11	XC	451	9%	77%												
	0.97	40	24	4.8-19	4-16	3.5-14	3-12	XC	436	10%	78%	UC	535	6%	50%								
	1.03	45	27	5-20	4.3-17	3.8-15	3-12	XC	423	11%	80%	UC	520	6%	53%								
	1.09	50	30	5.5-22	4.5-18	4-16	3.3-13	XC	412	11%	81%	UC	508	7%	55%	UC	584	5%	56%	UC	623	4%	50%
	1.19	60	36	6-24	5-20	4.5-18	3.5-14	VC	393	12%	83%	UC	486	8%	59%	UC	566	6%	59%	UC	605	4%	53%
	1.24	65	39	6.3-25	5-20	4.5-18	3.8-15	VC	385	13%	83%	XC	476	8%	61%	UC	558	6%	60%	UC	597	5%	54%
	1.29	70	42	6.3-25	5.3-21	4.8-19	3.8-15	C	377	13%	84%	XC	467	8%	62%	UC	551	6%	61%	UC	589	5%	55%
1.38	80	48	6.8-27	5.8-23	5-20	4-16	C	364	14%	85%	XC	451	9%	64%	UC	538	7%	63%	UC	577	5%	57%	
80-15 Nozzles	Flow us gpm	Boom psi	Tip psi	Application Speed (mph) @ 25-100% Duty Cycle				ER80-15 (40270-15)				SR80-15 (40288-15)				MR80-15 (40290-15)				DR80-15 (40280-15)			
	1.01	35	18	4.3-17	3.8-15	3-12	2.5-10	XC	477	6%	75%												
	1.08	40	21	4.5-18	4-16	3.5-14	2.8-11	XC	459	7%	76%												
	1.14	45	23	4.8-19	4.3-17	3.5-14	2.8-11	XC	444	8%	77%	UC	584	5%	41%								
	1.20	50	26	5-20	4.5-18	3.5-14	3-12	XC	430	9%	78%	UC	572	5%	44%								
	1.32	60	31	5.5-22	5-20	4-16	3.3-13	XC	408	10%	79%	UC	550	6%	48%	UC	509	7%	67%	UC	634	3%	49%
	1.37	65	34	5.8-23	5-20	4-16	3.5-14	XC	399	11%	80%	UC	540	6%	50%	UC	500	8%	68%	UC	625	3%	50%
	1.43	70	36	6-24	5.3-21	4.3-17	3.5-14	XC	390	12%	80%	UC	531	6%	51%	UC	491	8%	69%	UC	616	3%	51%
1.52	80	41	6.3-25	5.8-23	4.5-18	3.8-15	VC	375	13%	81%	UC	515	6%	54%	XC	476	9%	71%	UC	602	3%	54%	
80-20 Nozzles	Flow us gpm	Boom psi	Tip psi	Application Speed (mph) @ 25-100% Duty Cycle				ER80-20 (40270-20)				SR80-20 (40288-20)				MR80-20 (40290-20)				DR80-20 (40280-20)			
	1.30	45	17	6.5-26	4.8-19	3.3-13	2.4-9.6	UC	534	5%	64%												
	1.37	50	19	6.8-27	5-20	3.5-14	2.5-10	UC	520	6%	66%												
	1.50	60	23	7.5-30	5.5-22	3.8-15	2.8-11	UC	496	7%	69%	UC	587	5%	41%								
	1.56	65	24	7.8-31	5.8-23	3.8-15	3-12	UC	486	8%	70%	UC	577	5%	43%								
	1.62	70	26	8-32	6-24	4-16	3-12	XC	477	8%	71%	UC	568	5%	45%	UC	583	4%	56%	UC	648	3%	47%
	1.73	80	30	8.5-34	6.5-26	4.3-17	3.3-13	XC	460	9%	73%	UC	551	5%	48%	UC	564	5%	58%	UC	628	3%	50%

NOTE: 'SR, MR, DR, UR spray tips include pre-orifice(s). Pre-orifices are not interchangeable between different spray tips of different series. 'Shown application information is based on water @ 80°F in a controlled environment and should not be considered actual. Information is provided for comparison to other Combo-Jet® spray tips, for educational purposes only. Repeat testing results can vary.

COMBO-JET 110° Spray Tips - PWM Spray Systems

Comprehensive rate & speed charts for any nozzle spacing/speed/rate is available on Tip Wizard. Try it today!

⚠ Disclaimer: These charts are published for comparative purposes to demonstrate the differences in the series of Combo-Jet® spray tips. Data used to populate this chart is extrapolated from third party testing data from a controlled conditions test with water as the testing solution. Actual spray applications with active chemical ingredients may change the spray dynamics and spray tip performance specifications. Wilger is not liable for any misuse or misrepresentation of this information, leading to (but not limited to) incorrect spray application, crop damage, or any other harm. (Not limited to human, livestock or environmental). Always verify these charts with the most recent charts found on the www.wilger.net, and ALWAYS follow chemical label nozzle requirements.

<p>ASABE Spray Classification (ASABE S572.1 Standard) Spray quality is categorized based on Dv0.1 and VMD droplet sizes. Objective testing data (by 3rd party), from spray spectrum recording equipment (without wind tunnel use), has been used to classify spray quality for this chart. Extra data (e.g. VMD, etc.) can vary between testing equipment and method, and is provided as an educational reference only. <small>Tips sized up to 110-06 verified on Phase Doppler Particle Analyzer (PDPA); tips sized over 110-06 verified on Malvern</small></p>	<ul style="list-style-type: none"> ■ Fine (F) ■ Medium (M) ■ Coarse (C) ■ Very Coarse (VC) ■ Extremely Coarse (XC) ■ Ultra Coarse (UC) 	<p>VMD (Volume Median Diameter) The median droplet (in μ) for a sprayed volume. Half of the volume is made of droplets smaller, with half made up of droplets larger.</p>	<p>% <141μ (% Driftable Fines) Percentage of volume which is likely to drift. As wind & boom height increase, observed spray drift will increase substantially.</p>	<p>% <600μ (% of Small Droplets) % of volume which is made up of 'small' droplets, useful for coverage. As % of useful droplets lowers, overall coverage is reduced.</p>
-------------------------------------------------------------------------------------------------------------------------------------------------------------------------------------------------------------------------------------------------------------------------------------------------------------------------------------------------------------------------------------------------------------------------------------------------------------------------------------------------------------------------------------------------------------------------------------------------------------------------	---------------------------------------------------------------------------------------------------------------------------------------------------------------------------------------------------------------------------------------------------------------------------------------------------------------------------------------------------------------------------------------------------------------------	-------------------------------------------------------------------------------------------------------------------------------------------------------------------------------------------------------	--------------------------------------------------------------------------------------------------------------------------------------------------------------------------------------------------------	---------------------------------------------------------------------------------------------------------------------------------------------------------------------------------------------------------

Nozzle Angle & Sizes	Flow Rate USGPM	Boom Pressure PSI	Tip PSI	Application Rate - US Gallons/Acre on 20" Spacing w/ PWM Sprayer System				Spray Classification, VMD (Droplet Size in μ): %<141μ (Drift %); %<600μ (Small Droplets)																							
								@ Sprayer Speed MPH (25-100% Duty Cycle)				ER110° Series		SR110° Series		MR110° Series		DR110° Series		UR Series											
				Flow us gpm	Boom psi	Tip psi	Application Speed (mph) @ 25-100% D.C.	2gpa	3gpa	4gpa	5gpa	CLASS	VMD	<141	<600	CLASS	VMD	<141	<600	CLASS	VMD	<141	<600	CLASS	VMD	<141	<600	CLASS	VMD		
110-01 Nozzles	0.07	20	20	2.8-11	1.8-7	1.3-5.3	1.1-4.2	F	149	45%	100%																				
	110-015 Nozzles	0.11	20	20	2.5-10	2.5-10	1.6-6.3	1.3-5.2	F	153	40%	100%																			
		110-02 Nozzles	0.14	20	20	3.5-14	2.5-10	2.1-8.3	1.7-6.9	F	173	32%	100%																		
			110-025 Nozzles	0.17	20	19	4.3-17	3.3-13	2.5-10	2.2-8.6	F	194	28%	100%																	
				110-03 Nozzles	0.21	20	19	3.8-15	3-12	2.5-10	1.9-7.7	F	199	26%	99%																

NOTE: *SR, MR, DR, UR spray tips include pre-orifice(s). Pre-orifices are not interchangeable between different spray tips of different series. *Shown application information is based on water @ 80°F in a controlled environment and should not be considered actual. Information is provided for comparison to other Combo-Jet® spray tips, for educational purposes only. Repeat testing results can vary.

COMBO-JET 110° Spray Tips - PWM Spray Systems

Comprehensive rate & speed charts for any nozzle spacing/speed/rate is available on Tip Wizard. Try it today!

Nozzle Angle & Sizes	Flow Rate USGPM	Boom Pressure PSI	Tip PSI	Application Rate - US Gallons/Acre on 20" Spacing w/ PWM Sprayer System				Spray Classification, VMD (Droplet Size in µ); %<141µ (Drift %); %<600µ (Small Droplets)																		
				@ Spray Speed (25-100% Duty Cycle) - Mph				ER110° Series			SR110° Series			MR110° Series			DR110° Series			UR series						
				Flow us gpm	Boom psi	Tip psi	Application Speed (mph) @ 25-100% D.C.	Class	VMD	<141	<600	Class	VMD	<141	<600	Class	VMD	<141	<600	Class	VMD	<141	<600	Class	VMD	<141
110 -04 Nozzles	0.27	20	19	5-20	4-16	2.8-11	2-8.1	M	243	18%	97%															
	0.31	25	23	5.8-23	4.5-18	3-12	2.3-9.1	M	235	20%	97%	C	330	9%	93%											
	0.34	30	28	6.3-25	5-20	3.3-13	2.5-10	M	228	21%	97%	C	314	11%	94%	VC	425	4%	83%	XC	519	3%	67%			
	0.36	35	33	6.8-27	5.5-22	3.5-14	2.8-11	M	222	23%	97%	C	300	12%	95%	VC	404	5%	86%	XC	497	3%	71%	UC	621	
	0.39	40	37	7.3-29	5.8-23	3.8-15	3-12	M	217	24%	97%	C	288	14%	95%	C	386	6%	88%	XC	478	4%	74%	UC	601	
	0.41	45	42	7.5-30	6-24	4-16	3-12	F	213	25%	96%	C	278	15%	96%	C	370	7%	90%	VC	462	4%	77%	UC	583	
	0.43	50	47	8-32	6.5-26	4.3-17	3.3-13	F	209	26%	96%	M	269	16%	96%	C	355	8%	91%	VC	447	5%	79%	UC	567	
	0.47	60	56	8.8-35	7-28	4.8-19	3.5-14	F	202	27%	96%	M	253	17%	96%	C	330	9%	93%	VC	421	6%	82%	UC	539	
	0.49	65	61	9.3-37	7.3-29	5-20	3.8-15	F	199	28%	96%	M	246	18%	97%	C	319	9%	94%	VC	410	6%	83%	UC	527	
	0.51	70	66	9.5-38	7.5-30	5-20	3.8-15	F	196	29%	96%	M	239	19%	97%	C	309	10%	95%	C	400	6%	84%	UC	516	
	0.55	80	75	10-41	8.3-33	5.5-22	4-16	F	191	30%	95%	M	228	20%	97%	C	291	11%	95%	C	381	7%	86%	UC	496	
	110 -05 Nozzles	0.34	20	18	4.3-17	3-12	2.5-10	2.1-8.3	M	253	17%	95%														
0.38		25	23	4.8-19	3.5-14	2.8-11	2.3-9.3	M	242	19%	95%	C	377	7%	89%											
0.41		30	27	5-20	3.8-15	3-12	2.5-10	M	233	21%	95%	C	355	8%	91%	XC	501	3%	69%	XC	539	2%	61%			
0.45		35	32	5.5-22	4.3-17	3.3-13	2.8-11	M	225	23%	95%	C	338	10%	93%	XC	478	4%	73%	XC	525	2%	64%	UC	638	
0.48		40	36	6-24	4.5-18	3.5-14	3-12	M	219	25%	95%	C	322	11%	93%	VC	459	4%	76%	XC	513	3%	66%	UC	621	
0.50		45	41	6.3-25	4.8-19	3.8-15	3-12	F	213	26%	95%	C	309	12%	94%	VC	442	5%	78%	XC	502	3%	68%	UC	605	
0.53		50	45	6.5-26	5-20	4-16	3.3-13	F	208	27%	95%	C	296	13%	95%	VC	427	5%	80%	XC	492	3%	70%	UC	592	
0.58		60	54	7.3-29	5.5-22	4.3-17	3.5-14	F	199	29%	95%	C	275	15%	96%	C	400	6%	83%	XC	475	3%	73%	UC	570	
0.61		65	59	7.5-30	5.8-23	4.5-18	3.8-15	F	195	30%	95%	M	266	16%	96%	C	389	6%	84%	XC	467	3%	74%	UC	560	
0.63		70	63	7.8-31	5.8-23	4.8-19	4-16	F	191	31%	95%	M	257	16%	96%	C	378	7%	85%	XC	460	4%	75%	UC	551	
0.67		80	72	8.3-33	6.3-25	5-20	4.3-17	F	185	32%	95%	M	242	17%	97%	C	359	7%	87%	VC	448	4%	77%	UC	536	
110 -06 Nozzles		0.44	25	22	4.5-18	3.3-13	2.8-11	2.2-8.8	C	278	15%	94%	VC	444	4%	80%	XC	545	2%	58%	XC	605	1%	49%	UC	701
	0.48	30	26	4.8-19	3.5-14	3-12	2.4-9.6	M	268	16%	94%	VC	416	6%	84%	XC	524	3%	64%	XC	583	2%	54%	UC	674	
	0.52	35	30	5.3-21	4-16	3.3-13	2.5-10	M	260	18%	94%	C	392	7%	87%	XC	506	3%	68%	XC	563	2%	58%	UC	652	
	0.56	40	35	5.5-22	4.3-17	3.5-14	2.8-11	M	253	19%	94%	C	371	8%	89%	XC	490	3%	71%	XC	547	2%	61%	UC	633	
	0.59	45	39	6-24	4.5-18	3.8-15	3-12	M	247	20%	94%	C	353	9%	90%	XC	477	4%	74%	XC	532	2%	63%	UC	617	
	0.63	50	43	6.3-25	4.8-19	3.8-15	3-12	M	242	21%	95%	C	337	10%	92%	XC	465	4%	76%	XC	519	3%	65%	UC	603	
	0.69	60	52	6.8-27	5-20	4.3-17	3.5-14	M	233	23%	95%	C	308	12%	93%	VC	443	5%	79%	XC	496	3%	69%	UC	580	
	0.71	65	57	7-28	5.3-21	4.5-18	3.5-14	M	228	23%	95%	C	296	13%	94%	VC	434	5%	80%	XC	486	3%	70%	UC	570	
	0.74	70	61	7.3-29	5.5-22	4.5-18	3.8-15	M	225	24%	95%	C	284	13%	94%	VC	426	5%	81%	XC	476	3%	71%	UC	560	
	0.79	80	70	7.8-31	6-24	5-20	4-16	F	218	25%	95%	M	264	14%	95%	VC	410	5%	83%	XC	460	3%	73%	UC	544	
	110 -08 Nozzles	0.44	25	22	4.5-18	3.3-13	2.8-11	2.2-8.8	C	328	14%	90%														
		0.48	30	26	4.8-19	3.5-14	3-12	2.4-9.6	C	312	15%	92%	XC	453	6%	67%										
0.52		35	30	5.3-21	4-16	3.3-13	2.5-10	C	298	17%	93%	XC	429	7%	71%	UC	545	4%	50%	UC	627	3%	38%			
0.56		40	35	5.5-22	4.3-17	3.5-14	2.8-11	C	286	18%	93%	XC	408	7%	74%	UC	522	4%	54%	UC	606	3%	42%	UC	651	
0.59		45	39	6-24	4.5-18	3.8-15	3-12	M	275	19%	94%	XC	390	8%	77%	UC	503	5%	58%	UC	588	3%	44%	UC	632	
0.63		50	43	6.3-25	4.8-19	3.8-15	3-12	M	266	20%	95%	VC	374	9%	79%	UC	486	5%	61%	UC	571	4%	47%	UC	614	
0.69		60	52	6.8-27	5-20	4.3-17	3.5-14	M	249	21%	95%	C	346	10%	82%	XC	455	6%	65%	UC	543	4%	50%	UC	585	
0.71		65	57	7-28	5.3-21	4.5-18	3.5-14	M	242	22%	96%	C	334	10%	83%	XC	442	6%	67%	UC	530	4%	52%	UC	573	
0.74		70	61	7.3-29	5.5-22	4.5-18	3.8-15	M	235	23%	96%	C	322	11%	84%	XC	430	6%	69%	UC	519	4%	53%	UC	562	
0.79		80	70	7.8-31	6-24	5-20	4-16	F	223	24%	96%	C	302	11%	86%	XC	408	7%	71%	UC	498	4%	56%	UC	543	
110 -10 Nozzles		0.73	30	21	3.5-14	3-12	2.8-11	2.2-8.6	VC	357	11%	88%	XC	470	6%	62%	UC	579	3%	43%	UC	639	4%	63%	UC	711
		0.79	35	25	4-16	3.3-13	3-12	2.3-9.3	C	343	12%	89%	XC	445	7%	67%	UC	554	4%	48%	UC	625	5%	61%	UC	682
	0.84	40	28	4.3-17	3.5-14	3-12	2.5-10	C	330	13%	90%	XC	424	7%	70%	UC	533	4%	51%	UC	614	5%	59%	UC	658	
	0.89	45	32	4.5-18	3.8-15	3.3-13	2.8-11	C	319	15%	91%	XC	405	8%	73%	UC	514	4%	54%	UC	604	5%	58%	UC	637	
	0.94	50	35	4.8-19	4-16	3.5-14	2.8-11	C	310	16%	91%	XC	388	8%	75%	UC	497	5%	57%	UC	595	5%	56%	UC	620	
	1.03	60	42	5-20	4.3-17	3.8-15	3-12	C	293	17%	92%	VC	358	9%	79%	XC	468	5%	61%	UC	580	5%	54%	UC	590	
	1.07	65	46	5.3-21	4.5-18	4-16	3.3-13	C	285	18%	92%	C	345	10%	80%	XC	456	5%	62%	UC	573	5%	53%	UC	577	
	1.11	70	49	5.5-22	4.5-18	4.3-17	3.3-13	C	278	19%	93%	C	333	10%	81%	XC	444	6%	64%	UC	566	5%	51%	UC	566	
	1.19	80	56	6-24	5-20	4.5-18	3.5-14	M	266	20%	93%	C	311	11%	83%	XC	423	6%	66%	UC	555	6%	49%	UC	546	
	110 -125 Nozzles	1.08	30	18	5.3-21	4.5-18	4-16	3.3-13	XC	447	8%	64%														
		1.17	35	21	5.8-23	4.8-19	4.3-17	3.5-14	XC	430	8%	68%														
		1.25	40	24	6.3-25	5.3-21	4.8-19	3.8-15	XC	416	9%	71%	XC	445	5%	66%										
1.33		45	27	6.5-26	5.5-22	5-20	4-16																			

NEW

COMBO-JET® Narrow-Angle Nozzles for Specialty/Spot Spraying

A full selection of narrow angle spray nozzles for use in specialty applications that require a narrow, but thick pattern. These nozzles are fully compatible with PWM spray systems, and other optical spray systems. Contact factory for availability.

What is optical spot spraying?

Optical spraying systems, or spot spraying based on optical feedback is used for a variety of purposes and with different mode of actions.

Spray on Green

Optics identify 'green' targets in field, and sprays them.

Examples include:

- Spraying herbicides to clear out established weeds before planting.
- Spraying Fungicide in-crop to any plants in field, skipping bare ground.
- Use more expensive modes of actions to manage resistant weeds.
- Foliar fertilizer applications on plant only

Green on Green

Optics & computer differentiate plants in field and spray target plants only.

Examples include:

- Spraying weeds ONLY with herbicide, avoiding planted crop.
- Spraying crop with fungicide, ignoring weeds or non-target plants.

While the potential benefits of **Green on Green** provide a great deal of flexibility & means to use cost-prohibitive herbicide regimens, the means to differentiate plants at application time and development of the computing power and learning mechanisms are continually under development.

COMBO-JET® ER & DX Series of 20°, 40° & 60° Narrow-Angle Spray Nozzles for Spot Spraying

A new series of DX drift reduction, narrow angle nozzles.

Nozzle Angle & Sizes	Flow Rate USGPM	Boom Pressure PSI	Application Rate in US Gallons / Acre on 20" Nozzle Spacing							20° Nozzles	40° Nozzles	60° Nozzles
			@ Sprayer Speed - Miles / Hour									

For smaller sizes of nozzles in narrow-angle varieties, please contact Wilger. As spot-spraying systems continue to develop, Wilger expects to have a variety of nozzles developed in turn to support the new improvements to maximize effectiveness.

	Flow us gpm	Boom psi	Application Speed (mph) @							DRIFT REDUCTION DX20-04 PART#	DRIFT REDUCTION DX40-04 PART#	DRIFT REDUCTION DX60-04 PART#
			8GPA	10GPA	12.5GPA	15GPA	18GPA	20GPA	25GPA			
-04 Nozzles	0.35	30	14	10	8	6.9	5.1	4.1	3.4	FINE SPRAY ER20-04 PART#	FINE SPRAY ER40-04 PART#	FINE SPRAY ER60-04 PART#
	0.40	40	16	12	10	7.9	5.9	4.8	4.0			
	0.45	50	18	13	11	9	6.6	5.3	4.4			
	0.49	60	19	15	12	10	7.3	5.8	4.8			
	0.53	70	21	16	13	10	8	6.3	5.2			
-05 Nozzles	0.43	30	13	10	9	7	6.4	5.1	4.3	FINE SPRAY ER20-05 PART#	FINE SPRAY ER40-05 PART#	FINE SPRAY ER60-05 PART#
	0.50	40	15	12	10	8	7.4	5.9	5.0			
	0.56	50	17	13	11	9	8	6.6	5.5			
	0.61	60	18	15	12	10	9	7	6.1			
	0.66	70	20	16	13	11	10	8	6.5			
-06 Nozzles	0.52	30	15	12	10	9	8	5.1	4.4	FINE SPRAY ER20-06 PART#	FINE SPRAY ER40-06 PART#	FINE SPRAY ER60-06 PART#
	0.60	40	18	14	12	10	9	6	5.1			
	0.67	50	20	16	13	11	10	7	6			
	0.73	60	22	17	15	12	11	7	6			
	0.79	70	24	19	16	13	12	8	7			
-08 Nozzles	0.69	30	14	11	10	8	7	6	5	FINE SPRAY ER20-08 PART#	FINE SPRAY ER40-08 PART#	FINE SPRAY ER60-08 PART#
	0.80	40	16	13	12	10	8	7	6			
	0.89	50	18	15	13	11	9	8	7			
	0.98	60	19	16	15	12	10	8	7			
	1.06	70	21	17	16	13	10	9	8			
-10 Nozzles	0.87	30	17	14	13	10	9	6	5	FINE SPRAY ER20-10 PART#	FINE SPRAY ER40-10 PART#	FINE SPRAY ER60-10 PART#
	1.00	40	20	17	15	12	10	7	6			
	1.12	50	22	18	17	13	11	8	7			
	1.22	60	24	20	18	15	12	9	7			
	1.32	70	26	22	20	16	13	10	8			
-125 Nozzles	1.08	30	16	13	11	9	8	7	6	FINE SPRAY ER20-125 PART#	FINE SPRAY ER40-125 PART#	FINE SPRAY ER60-125 PART#
	1.25	40	19	15	12	11	9	8	7			
	1.40	50	21	17	14	12	10	9	8			
	1.53	60	23	18	15	13	11	10	9			
	1.65	70	25	20	16	14	12	11	10			

For larger sizes of nozzles in narrow-angle varieties, please contact Wilger. As spot-spraying systems continue to develop, Wilger expects to have a variety of nozzles developed in turn to support the new improvements to maximize effectiveness.

What is the DX series of spray tip?

Effectively through development of the narrow angle nozzles, there seems to be a relative sweet spot for consistent coverage and maintaining a reasonable level of driftable fines.

Since optical/spot sprayers are commonly sharing a maximum speed and narrow spacing, it is easier to consolidate what Wilger finds as a good middle ground to offer a single drift reduction nozzle.

That being said, if you have a significant need for a coarser option than the DX nozzle, by all means contact Wilger and we would likely have something that might be made available to you.

Other uses for narrow-angle nozzles

Narrow angle spray nozzles are also key in improving some non-standard broadcast field spraying.

Narrower angle nozzles can be used in applications that specifically target certain parts of the plant where application to the rest of the plant is waste.

There are also cropping applications that might be continually cropping into **high stubble**, where traditional wide angle nozzles will result in significant spray catch and run-off in the stubble.

It is important to recognize narrow angle nozzles are not to be used strictly as replacements for nozzles that are intended for your sprayer (e.g. 80° or 110°). They are only an option to further isolate and target a spray target to achieve better spray efficiency and minimize chemical waste.

Are they still PWM-compatible?



Absolutely! The narrow angles use the same drift reduction design that is completely compatible with optical spray systems that are typically driven by PWM solenoids. The consistent thickness of the narrow angles make the key choices for optical spot sprayers for both compatibility and performance.

Are DX nozzles used on Drone Sprayers?

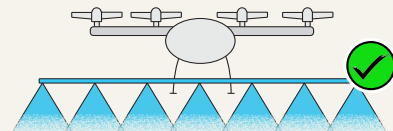

UAV sprayer applicators are able to use DX nozzles for targeted spray applications, but often due to boom constraints or UAV sprayer outfitting, wider angle nozzles like the MR110° nozzles might be used. In specialty circumstances that require a narrow full pattern spray can take advantage of the DX series of narrow-angle nozzles.

DX nozzles can be used on UAV sprayers, but they would likely be specialty applications or on sprayers that require very narrow spacing. Contact WILGER offices for smaller sizes of DX nozzles for Drone applications.

LERAP Drift Reduction Star Rating for COMBO-JET Spray Nozzles [For UK applicators]

Local Environmental Risk Assessments for Pesticides (LERAP) certification is completed in the UK to provide applications a means to qualify a local drift reduction assessment based on the nozzles used for an application. Stay tuned for further LERAP nozzle testing for more nozzles.

LERAP RATING	Nozzle	Pressure Range	LERAP RATING	Nozzle	Pressure Range
★★★★ 90% Drift Reduction	DR110-03	1.0 - 1.5 BAR	★★★ 75% Drift Reduction	DR110-025	1.0 - 2.5 BAR
	DR110-05	1.0 - 1.5 BAR		DR110-03	1.6 - 3.0 BAR
	DR110-06	1.0 - 3.0 BAR		DR110-04	1.0 - 5.0 BAR
	MR110-05	1.0 - 1.5 BAR		DR110-05	1.6 - 5.0 BAR
	MR110-06	1.0 - 1.5 BAR		DR110-06	3.1 - 5.0 BAR
				MR110-04	1.0 - 2.5 BAR
		MR110-05	1.6 - 5.0 BAR		
		MR110-06	1.6 - 5.0 BAR		
		SR110-05	1.0 - 1.5 BAR		

The 4-star LERAP rating is a new rating that illustrates the highest classification for drift reduction within the standard certification. (List updated January 2021)

For the updated list on COMBO-JET nozzles, visit www.wilger.net/LERAP

More information on LERAP certification, process, and the most up to date listing of approved nozzles and their ratings, is available from the Health and Safety Executive (HSE), also available online @ <https://secure.pesticides.gov.uk/SprayEquipment>

COMBO-JET® Cap Adapters

Order #####-V0 for viton o-ring assemblies





NOZZLES

Wilger manufactures a variety of adapters to adapt Wilger nozzles to other brands of nozzle bodies (e.g. Teejet, Hypro, Arag, etc) and vice versa. All adapters self-align cap to common nozzle offset.

<h3>Square Lug to COMBO-JET</h3>  <p>40204-00 Converts Square Lug (e.g. Teejet/Hypro) Outlet to COMBO-JET -TWISTLOCK-</p>	<h3>COMBO-JET to Square Lug</h3>  <p>40203-00 Converts COMBO-JET Outlet to Square Lug (e.g. Teejet/Hypro) -Quarter Turn-</p>	<h3>HARDI to COMBO-JET</h3>  <p>40202-00 Converts HARDI Outlet to COMBO-JET -Semi-permanent snap on adapter-</p>
<p>New</p> <h3>AGRIFAC to COMBO-JET</h3>  <p>40205-00 Converts Agrifac Outlet to COMBO-JET -Easy nozzle sleeve-snaps into any Combo-Jet nozzle</p>	<p>New</p> <h3>Square Lug to DOUBLE-DOWN</h3>  <p>40206-00 Converts Square Lug Outlet (e.g. Teejet/Hypro) to COMBO-JET Double-Down Outlets -TWISTLOCK-</p>	<p>New</p> <h3>JACTO to COMBO-JET</h3>  <p>40207-00 Converts Jacto Outlet to COMBO-JET -Quarter Turn-</p>

Radialock Slotted Caps (Compatible with COMBO-JET outlets)

Wilger manufactures a variety of caps for accepting flanged spray tips onto any Combo-Jet or Combo-Rate nozzle outlets. These caps require a spray tip gasket to seal, which is sold separately.

<h3>Gasket for Slotted Caps</h3>  <p>40160-00 EPDM Rubber Gasket for Flanged Tips & Radialock slotted caps Order 40160-V0 for viton gasket</p>	<h3>3/8" Slot</h3>  <p>40269-05 For 3/8" Teejet/Hypro spray tips</p>	<h3>1/2" Round Slot</h3>  <p>40271-05 For 1/2" round spray tips</p>	<h3>7/16" Wide Slot</h3>  <p>40276-05 For larger Teejet/Hypro spray tips</p>	<h3>HARDI Tip Slot</h3>  <p>40275-05 For HARDI brand spray tips</p>
<p>Available in colors: Grey (-09), Orange (-08), Brown (-07), Blue (-06), Black (-05), Yellow (-04), Green (-03), White (-02), Red (-01)</p>		<p>Available in colors*: Black (-05), Yellow (-04), Green (-03), White (-02), Red (-01) *Check factory availability of non-black colors.</p>		

Conventional Flat Fan Flanged Spray Tips (3/8" slot)

Wilger manufactures a variety of sizes of flanged stainless steel spray tips inserted permanently into a flanged spray tip assembly. These would correspond to Combo-Jet ER series of spray nozzle, as they are a conventional flat fan tip.

ER 80° Flanged Tips

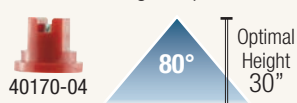

ER 110° Flanged Tips



Stainless Steel Insert

Color-coded to flow rate & stamped for easy identification

Tip Size	-005	-0067	-01	-015	-02	-025	-03	-04	-05	-06	-08
80° ER Tip	ER80-005	ER80-007	ER80-01	ER80-015	ER80-02	ER80-025	ER80-03	ER80-04	ER80-05	ER80-06	ER80-08
Part #	40170-005	40170-007	40170-01	40170-015	40170-02	40170-025	40170-03	40170-04	40170-05	40170-06	40170-08
110° ER Tip	-	-	ER110-01	ER110-015	ER110-02	ER110-025	ER110-03	ER110-04	ER110-05	ER110-06	ER110-08
Part #	-	-	40169-01	40169-015	40169-02	40169-025	40169-03	40169-04	40169-05	40169-06	40169-08

For flow rate charts, spray quality, and more information on flanged spray tips, reference the 80° and 110° spray nozzle charts.

COMBO-JET® Caps, Adapters & Strainers

Wilger manufactures a variety of caps that are used for metering flow rates (through hose barb, push-in tube, or streamer caps) or used as accessories for other spraying or plumbing functions.

Plug Caps



Caps unused Combo-Jet nozzle body outlets

40272-B5

Plug Cap	
Assembled Plug	Cap Only
40272-B5	40272-05

Threaded Outlet Adapters



Threaded adapter caps can be used for any application that would require a threaded fitting.

Threaded Outlet Caps		
Thread Size	FKM O-ring Assy	Cap Only
1/8" NPT-F	40277-B5	40277-05
1/4" NPT-F	40273-B5	40273-05
45° 1/4" NPT-F	40274-B5	40274-05

Hose Barb Caps



Hose barb caps can be used as manifold plumbing parts or for metering flow.

Hose Barb Caps		
Barb Size	FKM O-ring Assy	Cap Only
1/8"	40420-B5	40420-05
1/4"	40422-B5	40422-05
3/8"	40424-B5	40424-05
1/2"	40426-B5	40426-05

To use cap for metering, order CAP ONLY, with o-ring and 40285-## metering orifice.

Push-in-Tube Caps



Quick connect tube caps seal on the outside diameter of a tube, and used as manifold plumbing parts or for metering flow.

Quick Connect/Push-in-tube Caps		
Tube Size (O.D.)	FKM O-ring Assy	Cap Only
1/4"	40435-B5	40435-05
5/16"	40437-B5	40437-05
3/8"	40436-B5	40436-05

To use cap for metering, order CAP ONLY, with o-ring and 40285-## metering orifice.

COMBO-JET Cap O-rings



40260-00
FKM

13mm x 3mm o-ring for COMBO-JET® Caps & Spray Tips



40260-V0
viton



40261-00

Adapter for non-metering caps
Seal adapter is used to keep o-ring in place if metering orifice is NOT used

COMBO-JET Snap-in Strainers

Combo-jet strainers snap into the metering orifice or seal adapter for a 'one-piece'-handling cap



40250-00



40251-00



40249-00



40248-00

Strainers			
Mesh Size	Slotted Strainer	Stainless Mesh	Color
100 mesh	-	#40251-00	Green
50 mesh	40249-00	#40250-00	Blue
25 mesh	40248-00	-	Yellow
16 mesh	40247-00	-	Gray

Double Nozzle Spraying Adapters

Be sure to read the 'Tip Selection Guide for Double Nozzle Spraying

Y-Adapter or 'Double-Down' mode?

To split up a high volume, coarse spray nozzle into two more meaningful spray qualities. Y-adapter is excellent for vertical growing targets, double-down is better into thick canopies.

PWM-Ready Double Nozzle Spraying

Just add the two nozzle sizes together for your PWM nozzle flow*

For example: MR110-04 + SR110-06 = 110-10

*PWM solenoid pressure drop would be based on -10 size

Y Splitter [60° Forward/Back]



40440-00

Spray forward and backward for high volume and fungicide spray applications.

Y Splitter Cap (60° forward, 60° backward)		
Cap ONLY	w/ FKM O-ring	w/ viton O-ring
40440-01	40440-00	40440-V0

New Double-Down Adapter



40441-00

Splitter used to spray with two nozzles to make more effective spray quality

Double-Down Adapter Cap		
Cap ONLY	w/ FKM O-ring	w/ viton O-ring
40441-01	40441-00	40441-V0

2-Hole & 3-Hole Streamer Caps



2-hole streamer caps are used to stream liquid fertilizer for 10" coverage

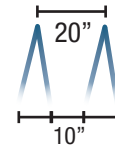

3-hole streamer caps are used to stream liquid fertilizer for ~6.67" coverage

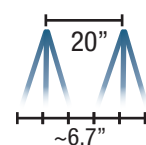

Drilled Fertilizer Streamer Caps [CAP ONLY]			
Cap Size	Flow Range	2-Hole Cap	3-Hole Cap
Small	0.05 - 0.4 us gpm	40432-047	40433-047
Medium	0.2 - 1.0 us gpm	40432-086	40433-086
Large	0.5 - 3.0 us gpm	40432-104	40433-104

-B5' Assembly Breakdown - For non-metering apps

For applications that do not require liquid metering orifices (e.g. plumbing manifolds), the -B5 is an assembly that includes an o-ring (#40260-00), seal adapter (#40261-00 in lieu of orifice), and cap.

New Hose Drop & Extension Caps

Hose Drop Caps are used to feed or spray down below a canopy to minimize crop contact.

Outlet	Length	Part #
Combo-Jet to Combo-Jet	2"	40210-00
	5"	40211-00
Combo-Jet Cap to 1/4" NPT-M	16"	22026-00
	24"	22036-00
	36"	22038-00
	48"	22048-00



Other styles of Hose Drop Assemblies using threaded inlets are also available. Find them in the DRY BOOMS section of the catalog.

Ordering [Drilled] Streamer Caps

For drilled streamer cap assembly, order:

1. Metering Orifice (40285-## series)*
2. Streamer cap (2 or 3 hole, sized to flow range)
3. O-ring seal (40260-00 or 40260-V0)
4. [Optional] Slotted Strainer

*For selecting metering orifices to fit your application, use Tip Wizard, consult flow charts, or use other tools available at www.wilger.net

Molded 3-hole Streamers Available in 2022.



Deflector Plate 3-hole fertilizer streamer nozzle improves stream consistency at higher pressures for improved application.

Next page for info.

COMBO-JET[®] Metering Orifices & Fertilizer Streamer Caps

COMBO-JET[®] Fertilizer Streamer Caps

Color-coded 3-hole streamer nozzles designed for streaming liquid fertilizer on consistent spacing to minimize leaf burn.

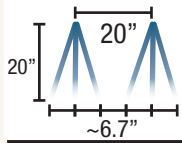

Operating Pressure	10-60 PSI
O-rings	FKM (viton avail.)
Material	Glass-reinforced Polypropylene



COMBO-JET[®] Metering Orifices

Metering orifice snap into any Combo-Jet or Radialock caps to meter fertilizer or chemical flow rates.

40249-00
50 Mesh Strainer



Short style orifices are compatible with Combo-Jet snap-in strainers.

40285-04 40285-15

*Some metering orifices have long stems, as they do not require strainers

UR series Orifices











If you are looking for replacement two-piece pre-orifices for Combo-Jet UR series spray tips, visit the UR series spray tip page for part numbers.



Combo-Jet Streamer Nozzle Size	Metering Orifice Size	Pres. (PSI)	Flow Rate (us gpm)	10" Outlet Spacing			12" Outlet Spacing			15" Outlet Spacing			20" Outlet Spacing			30" Outlet Spacing			
				Application Rates (GPA) @															
Using Tip Wizard makes selecting metering orifices & streamer caps easy! TRIAL FREE AT www.WILGER.NET Download on the App Store GET IT ON Google Play	-005 COMBO-JET Metering Orifice 40285-005	15	0.03	4.0	3.6	2.8	3.3	3.0	2.3	2.7	2.4	1.9	1.4	1	1	1	1.3	1.2	0.9
		20	0.04	4.6	4.2	3.2	3.9	3.5	2.7	3.1	2.8	2.1	1.6	1.2	0.8	1.5	1.4	1.1	
		25	0.04	5.2	4.7	3.6	4.3	3.9	3.0	3.5	3.1	2.4	1.7	1.3	0.9	1.7	1.6	1.2	
		30	0.04	5.7	5.1	3.9	4.7	4.3	3.3	3.8	3.4	2.6	1.8	1.4	0.9	1.9	1.7	1.3	
		35	0.05	6.1	5.5	4.2	5.1	4.6	3.5	4.1	3.7	2.8	2	1.5	1	2.0	1.8	1.4	
		40	0.05	6.6	5.9	4.5	5.5	4.9	3.8	4.4	3.9	3.0	2.1	1.6	1	2.2	2.0	1.5	
	-0067 COMBO-JET Metering Orifice 40285-007	15	0.04	5.4	4.9	3.7	4.5	4.1	3.1	3.6	3.2	2.5	1.9	1.4	0.9	1.8	1.6	1.2	
		20	0.05	6.3	5.6	4.3	5.2	4.7	3.6	4.2	3.8	2.9	2.1	1.6	1	2.1	1.9	1.4	
		25	0.05	7.0	6.3	4.8	5.8	5.2	4.0	4.7	4.2	3.2	2.3	1.7	1.1	2.3	2.1	1.6	
		30	0.06	7.7	6.9	5.3	6.4	5.7	4.4	5.1	4.6	3.5	2.5	1.9	1.2	2.6	2.3	1.8	
		35	0.06	8.3	7.4	5.7	6.9	6.2	4.8	5.5	5.0	3.8	2.7	2	1.3	2.8	2.5	1.9	
		40	0.07	8.8	8.0	6.1	7.4	6.6	5.1	5.9	5.3	4.1	2.8	2.1	1.4	2.9	2.7	2.0	
	-01 COMBO-JET Metering Orifice 40285-01	15	0.06	8.1	7.3	5.6	6.8	6.1	4.7	5.4	4.9	3.7	2.8	2.1	1.4	2.7	2.4	1.9	
		20	0.07	9.4	8.4	6.5	7.8	7.0	5.4	6.3	5.6	4.3	3.1	2.4	1.6	3.1	2.8	2.2	
		25	0.08	10	9.4	7.3	8.7	7.9	6.0	7.0	6.3	4.8	3.4	2.6	1.7	3.5	3.1	2.4	
30		0.09	11	10	8	10	8.6	6.6	7.7	6.9	5.3	3.7	2.8	1.9	3.8	3.4	2.7		
35		0.09	12	11	9	10	9.3	7.2	8.3	7.4	5.7	4	3	2	4.1	3.7	2.9		
40		0.10	13	12	9	11	10	7.7	8.8	8.0	6.1	4.2	3.2	2.1	4.4	4.0	3.1		
40443-015	15	0.09	12	11	8.4	10	9.1	7.0	8.1	7.3	5.6	4.2	3.2	2.1	4.0	3.6	2.8		
	20	0.11	14	13	10	12	11	8.1	9.3	8.4	6.5	4.7	3.5	2.3	4.7	4.2	3.2		
	25	0.12	16	14	11	13	12	9.0	10	9.4	7.2	5.1	3.9	2.6	5.2	4.7	3.6		
	30	0.13	17	15	12	14	13	10	11	10	7.9	5.6	4.2	2.8	5.7	5.1	4.0		
	35	0.14	19	17	13	15	14	11	12	11	8.6	5.9	4.5	3	6.2	5.6	4.3		
	40	0.15	20	18	14	17	15	11	13	12	9.1	6.3	4.7	3.2	6.6	5.9	4.6		
40443-02	15	0.12	16	15	11	13	12	9.3	11	10	7.4	5.6	4.2	2.8	5.4	4.8	3.7		
	20	0.14	19	17	13	16	14	11	12	11	8.6	6.2	4.7	3.1	6.2	5.6	4.3		
	25	0.16	21	19	14	17	16	12	14	12	10	6.8	5.1	3.4	6.9	6.2	4.8		
	30	0.17	23	21	16	19	17	13	15	14	11	7.4	5.5	3.7	7.6	6.8	5.3		
	35	0.19	25	22	17	21	18	14	16	15	11	7.9	5.9	4	8.2	7.4	5.7		
	40	0.20	26	24	18	22	20	15	18	16	12	8.4	6.3	4.2	8.8	7.9	6.1		
40443-025	15	0.15	20	18	14	17	15	12	13	12	9.3	7	5.2	3.5	6.7	6.1	4.7		
	20	0.18	23	21	16	19	17	13	16	14	11	7.8	5.9	3.9	7.8	7.0	5.4		
	25	0.20	26	23	18	22	20	15	17	16	12	8.6	6.4	4.3	8.7	7.8	6.0		
	30	0.22	29	26	20	24	21	16	19	17	13	9.2	6.9	4.6	10	8.6	6.6		
	35	0.23	31	28	21	26	23	18	21	18	14	9.9	7.4	4.9	10	9.2	7.1		
	40	0.25	33	30	23	27	25	19	22	20	15	10	7.9	5.2	11	10	7.6		
40443-03	15	0.18	24	22	17	20	18	14	16	15	11	8.4	6.3	4.2	8.1	7.3	5.6		
	20	0.21	28	25	19	23	21	16	19	17	13	9.4	7	4.7	9.3	8.4	6.5		
	25	0.24	31	28	22	26	23	18	21	19	14	10	7.7	5.1	10	9.4	7.2		
	30	0.26	34	31	24	29	26	20	23	21	16	11	8.3	5.6	11	10	7.9		
	35	0.28	37	33	26	31	28	21	25	22	17	12	8.9	5.9	12	11	8.6		
	40	0.30	40	36	27	33	30	23	26	24	18	13	9.5	6.3	13	12	9.1		
40443-04	15	0.24	32	29	22	27	24	19	22	19	15	11	8.4	5.6	11	10	7.5		
	20	0.28	37	34	26	31	28	22	25	22	17	13	9.4	6.3	12	11	8.6		
	25	0.32	42	38	29	35	31	24	28	25	19	14	10	6.9	14	13	10		
	30	0.35	46	41	32	38	34	26	30	27	21	15	11	7.4	15	14	11		
	35	0.37	49	44	34	41	37	28	33	30	23	16	12	7.9	16	15	11		
	40	0.40	53	47	37	44	40	30	35	32	24	17	13	8.4	18	16	12		
40443-05	15	0.31	40	36	28	34	30	23	27	24	19	12	9.1	6.1	13	12	9.3		
	20	0.35	47	42	32	39	35	27	31	28	22	14	11	7	16	14	11		
	25	0.40	52	47	36	43	39	30	35	31	24	16	12	7.8	17	16	12		
	30	0.43	57	51	40	48	43	33	38	34	26	17	13	8.6	19	17	13		
	35	0.47	62	56	43	51	46	36	41	37	28	19	14	9.3	21	19	14		
	40	0.50	66	59	46	55	49	38	44	40	30	20	15	9.9	22	20	15		
		45	0.53	70	63	48	58	53	40	47	42	32	21	16	23	21	16		

COMBO-JET[®] Metering Orifices (cont'd)

Common Liquid Weight, Specific Gravity, and Conversion Factor for Flow Rate:	[WATER] 8.34 lbs/gal Specific Gravity 1.0 Conversion Factor: 1.00	[28-0-0] 10.67 lbs/gal Specific Gravity 1.28 Conversion Factor: 1.13	[10-34-0] 11.65 lbs/gal Specific Gravity 1.28 Conversion Factor: 1.18
Required Flow Rate x Conversion Factor = Flow Rate adjusted for density			

	Metering Orifice Size	Pres. (PSI)	Flow Rate (us gpm)	10" Outlet Spacing			12" Outlet Spacing			15" Outlet Spacing			20" Outlet Spacing			30" Outlet Spacing			
				Application Rates (GPA) @			Application Rates (GPA) @			Application Rates (GPA) @			Application Rates (GPA) @			Application Rates (GPA) @			
				4.5 MPH	5.0 MPH	6.5 MPH	4.5 MPH	5.0 MPH	6.5 MPH	4.5 MPH	5.0 MPH	6.5 MPH	7.5 MPH	10 MPH	15 MPH	4.5 MPH	5.0 MPH	6.5 MPH	
	-06 COMBO-JET Metering Orifice 40285-06	40443-06	15	0.37	49	44	34	40	36	28	32	29	22	15	11	7.3	16	15	11
			20	0.42	56	50	39	47	42	32	37	34	26	17	13	8.4	19	17	13
			25	0.47	63	56	43	52	47	36	42	38	29	19	14	9.4	21	19	14
			30	0.52	69	62	48	57	51	40	46	41	32	21	15	10	23	21	16
			35	0.56	74	67	51	62	56	43	49	44	34	22	17	11	25	22	17
			40	0.60	79	71	55	66	59	46	53	48	37	24	18	12	26	24	18
			45	0.64	84	76	58	70	63	48	56	50	39	25	19	13	28	25	19
	-08 COMBO-JET [Short Orifice] 40285-08s [Long Orifice] 40285-08	40443-08	15	0.49	65	58	45	54	49	37	43	39	30	19	15	9.7	22	19	15
			20	0.57	75	67	52	62	56	43	50	45	34	22	17	11	25	22	17
			25	0.63	84	75	58	70	63	48	56	50	39	25	19	13	28	25	19
			30	0.69	91	82	63	76	69	53	61	55	42	27	21	14	30	27	21
			35	0.75	99	89	68	82	74	57	66	59	46	30	22	15	33	30	23
			40	0.80	106	95	73	88	79	61	70	63	49	32	24	16	35	32	24
			45	0.85	112	101	78	93	84	65	75	67	52	34	25	17	37	34	26
	-10 COMBO-JET [Short Orifice] 40285-10s [Long Orifice] 40285-10	40443-10	15	0.62	81	73	56	68	61	47	54	49	37	24	18	12	27	24	19
			20	0.71	94	84	65	78	70	54	63	56	43	28	21	14	31	28	22
			25	0.79	105	94	73	87	79	60	70	63	48	31	24	16	35	31	24
			30	0.87	115	103	80	96	86	66	77	69	53	34	26	17	38	34	27
			35	0.94	124	112	86	103	93	72	83	74	57	37	28	19	41	37	29
			40	1.00	133	119	92	111	99	77	88	80	61	40	30	20	44	40	31
			45	1.07	141	127	97	117	105	81	94	84	65	42	32	21	47	42	32
	-125 COMBO-JET [Short Orifice] 40285-125s [Long Orifice] 40285-125	40443-125	15	0.76	101	91	70	84	76	58	67	60	47	30	23	15	34	30	23
			20	0.88	116	105	81	97	87	67	78	70	54	35	26	17	39	35	27
			25	0.99	130	117	90	108	98	75	87	78	60	39	29	20	43	39	30
			30	1.08	143	128	99	119	107	82	95	86	66	43	32	21	48	43	33
			35	1.17	154	139	107	128	115	89	103	92	71	46	35	23	51	46	36
			40	1.25	165	148	114	137	123	95	110	99	76	49	37	25	55	49	38
			45	1.32	175	157	121	145	131	101	116	105	81	52	39	26	58	52	40
	-15 COMBO-JET [Long Orifice] 40285-15	40443-15	15	0.92	121	109	84	101	91	70	81	73	56	36	27	18	40	36	28
			20	1.06	140	126	97	117	105	81	93	84	65	42	32	21	47	42	32
			25	1.19	157	141	108	131	117	90	104	94	72	47	35	23	52	47	36
			30	1.30	172	154	119	143	129	99	114	103	79	51	39	26	57	51	40
			35	1.40	185	167	128	154	139	107	124	111	86	56	42	28	62	56	43
			40	1.50	198	178	137	165	149	114	132	119	91	59	45	30	66	59	46
			45	1.59	210	189	145	175	158	121	140	126	97	63	47	32	70	63	48
	-20 COMBO-JET [Long Orifice] 40285-20	40443-20	15	1.22	161	145	112	135	121	93	108	97	75	48	36	24	54	48	37
			20	1.41	186	168	129	155	140	108	124	112	86	56	42	28	62	56	43
			25	1.58	208	188	144	174	156	120	139	125	96	63	47	31	69	63	48
			30	1.73	228	206	158	190	171	132	152	137	105	69	51	34	76	69	53
			35	1.87	247	222	171	206	185	142	164	148	114	74	55	37	82	74	57
			40	2.00	264	237	183	220	198	152	176	158	122	79	59	40	88	79	61
			45	2.12	280	252	194	233	210	161	186	168	129	84	63	42	93	84	65
	-25 COMBO-JET [Long Orifice] 40285-25	40443-25	15	1.53	202	182	140	168	152	117	135	121	93	61	45	30	67	61	47
			20	1.77	233	210	162	194	175	135	156	140	108	70	53	35	78	70	54
			25	1.98	261	235	181	217	196	151	174	157	120	78	59	39	87	78	60
			30	2.17	286	257	198	238	214	165	191	171	132	86	64	43	95	86	66
			35	2.34	309	278	214	257	232	178	206	185	142	93	69	46	103	93	71
			40	2.50	330	297	228	275	247	190	220	198	152	99	74	49	110	99	76
			45	2.65	350	315	242	292	263	202	233	210	162	105	79	53	117	105	81
	-30 COMBO-JET [Long Orifice] 40285-30	40443-30	15	1.84	243	218	168	202	182	140	162	146	112	73	55	36	81	73	56
			20	2.12	280	252	194	234	210	162	187	168	129	84	63	42	93	84	65
			25	2.37	313	282	217	261	235	181	209	188	145	94	70	47	104	94	72
			30	2.60	343	309	238	286	257	198	229	206	158	103	77	51	114	103	79
			35	2.81	371	334	257	309	278	214	247	222	171	111	83	56	124	111	86
			40	3.00	396	357	274	330	297	229	264	238	183	119	89	59	132	119	91
			45	3.18	420	378	291	350	315	242	280	252	194	126	95	63	140	126	97
	-40 COMBO-JET [Long Orifice] 40285-40	40443-40	15	2.45	323	291	224	269	242	186	215	194	149	97	73	48	108	97	75
			20	2.83	373	336	258	311	280	215	249	224	172	112	84	56	124	112	86
			25	3.16	417	375	289	347	313	241	278	250	192	125	94	63	139	125	96
			30	3.46	457	411	316	381	343	263	304	274	211	137	103	69	152	137	105
			35	3.74	493	444	342	411	370	285	329	296	228	148	111	74	164	148	114
			40	4.00	527	475	365	439	396	304	352	316	243	158	119	79	176	158	122
			45	4.24	559	503	387	466	420	323	373	336	258	168	126	84	186	168	129
	-50 COMBO-JET [Long Orifice] 40285-50	40443-50	15	3.06	405	364	280	337	303	233	270	243	187	121	91	135	121	93	
			20	3.54	467	420	323	389	350	269	311	280	216	140	105	70	156	140	108
			25	3.96	522	470	362	435	392	301	348	313	241	157	118	78	174	157	121
			30	4.33	572	515	396	477	429	330	381	343	264	172	129	86	191	172	132
			35	4.68	618	556	428	515	463	356	412	371	285	185	139	93	206	185	143
			40	5.00	661	595	457	550	495	381	440	396	305	198	149	99	220	198	152
			45	5.31	701	631	485	584	525	404	467	420	323	210	158	105	234	210	162

COMBO-JET® Nozzle Bodies

W
E
T
B
O
O
M

The COMBO-JET® Advantage



Hinged Clamp for easy installation

Compact body sits directly under the boom. Perfect for tight boom frames & heavy PWM solenoids

Nozzle Bodies can swap right/left orientation to avoid sprayer boom frame

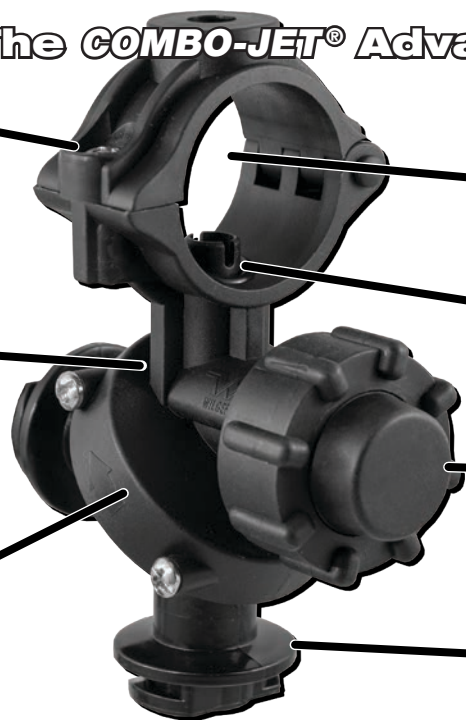

KWIKSTOP™ raised inlet option available to reduce nozzle run-on

Debris-cleaning 3/8" inlet slots for less residue buildup

Bodies can be equipped with any combination of control modules, including AIR-OFF, PWM solenoid, Manual ON/OFF or spring-based diaphragm check valves

Nozzle Bodies available in Combo-Jet or Square Lug styles (Teejet/Hypro/etc) with 1, 2 or 3 nozzle outlets

Single Outlet COMBO-JET® Nozzle Bodies

Robust and cost effective nozzle bodies for sprayers and used on wet boom liquid fertilizer kits.

Boom Pipe	Outlets	Style	Part#
3/4" (0.84" OD)	1 CJ	Check Valve	40611-00
1" (1.315" OD)	1 CJ	Check Valve	40621-00
		Manual On/Off	40621-MS
		No Module	40621-NM



40621-00 Single



40611-P15 Single Outlet w/ 15PSI check valve (red) and hose barb cap

Commonly used in liquid fertilizer metering manifolds mounted on plumbed pipe

KWIKSTOP™ stops Run-on

KWIKSTOP™ passively purges air trapped in the sprayer boom.

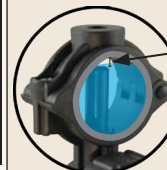

Nozzles are fed from the top of the pipe

Less air means Less Nozzle Run-on & Drips

KWIKSTOP™ is a trademark, owned by BRANDT INDUSTRIES LTD.

Dual Outlet COMBO-JET® Swivel Bodies

Robust and cost effective nozzle bodies for sprayers to switch up to two nozzles by simply rotating the outlet. Safer and easier than handling contaminated nozzles.

Boom Pipe	Outlets	Style	Part#
3/4" (0.84" OD)	2 CJ	Check Valve	40612-00
1" (1.315" OD)	2 CJ	Check Valve	40622-00
		Manual On/Off	40622-MS
		No Module	40622-NM



40622-00 Dual Swivel Combo-Jet



40622-NM Dual Swivel w/o Check Valve

Commonly used to cost effectively retrofit a sprayer to a PWM spray system

High/Low PSI Check Valves

Replace assembly part # ending '-00' to order 4PSI or 15PSI check valves



4 PSI '-P4' [BLUE] 10 PSI '-00' [Standard] 15 PSI '-P15' [RED]

Triple Outlet COMBO-JET® Swivel Bodies

Robust and cost effective nozzle bodies for sprayers to switch up to three nozzles by simply rotating the outlet. Safer and easier than handling contaminated nozzles.

Boom Pipe	Outlets	Style	Part#
3/4" (0.84" OD)	2 CJ	Check Valve	40612-00
1" (1.315" OD)	2 CJ	Check Valve	40622-00
		Manual On/Off	40622-MS
		No Module	40622-NM



40623-00 Triple Swivel Combo-Jet



40623-NM Triple Swivel w/o Check Valve

Commonly used to cost effectively retrofit a sprayer to a PWM spray system

1" KWIKSTOP™ Nozzle Bodies

Nozzle bodies with raised inlets to passively purge air trapped at the top of a sprayer boom pipe, reducing nozzle run-on & improving boom shut-off response times.

Boom Pipe	Outlets	Style	Part#
1" (1.315" OD)	1 CJ	Check Valve	40631-00
	2 CJ	Check Valve	40632-00
	3 CJ	Check Valve	40633-00



40631-00 Single w/ KWIKSTOP Raised inlet



Smooth Clamp Bodies

Swivel bodies have been switched to a standard bolt-mount hinge clamp.

Contact Wilger for a cross-reference chart for the smooth clamp part numbers and their bolt-mount replacement.

Nozzle Body Specifications

Operating Pressure	10"-125PSI
Single Outlet Flow Rate	2.1 us gpm @ 5PSI pressure drop 3.1 us gpm @ 10PSI pressure drop
Dual Swivel Flow Rate	1.7 us gpm @ 5PSI pressure drop 2.7 us gpm @ 10PSI pressure drop
Triple Swivel Flow Rate	1.6 us gpm @ 5PSI pressure drop 2.6 us gpm @ 10PSI pressure drop
O-ring Seals	FKM (viton avail.)
Materials	SS (screws) Polypropylene (body) Celcon (lower swivel)

Square Lug Swivel Nozzle Bodies & Accessories

Single Outlet Square Lug Nozzle Bodies

Robust and cost effective nozzle bodies for sprayers and used on wet boom liquid fertilizer kits.

Boom Pipe	Outlets	Style	Part#
3/4" (0.84" OD)	1 Square Lug	Check Valve	40651-00
		No Check	40140-00
1" (1.315" OD)	1 Square Lug	Check Valve	40661-00
		Manual On/Off	40661-MS
		No Module	40661-NM
		No Check	40141-00



40661-00
Single



40141-00
No Check Valve
Sq. Lug

Commonly used in liquid fertilizer metering manifolds mounted on plumbed pipe

KWIKSTOP™ stops Run-on

KWIKSTOP™ passively purges air trapped in the sprayer boom.

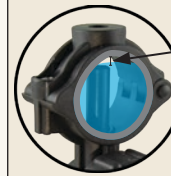

Nozzles are fed from the top of the pipe

Less air means Less Run-on & Drips

KWIKSTOP™ is a trademark, owned by BRANDT INDUSTRIES LTD.

Dual Outlet Square Lug Nozzle Bodies

Robust and cost effective nozzle bodies for sprayers to switch up to two nozzles by simply rotating the outlet. Safer and easier than handling contaminated nozzles.

Boom Pipe	Outlets	Style	Part#
3/4" (0.84" OD)	2 Square Lug	Check Valve	40652-00
		No Check	40140-00
1" (1.315" OD)	2 Square Lug	Check Valve	40662-00
		Manual On/Off	40662-MS
		No Module	40662-NM
		No Check	40141-00



40662-00
Dual Swivel
Sq. Lug



40662-NM
Dual Swivel
Sq. Lug

Commonly used to cost effectively retrofit a sprayer to a PWM spray system

High/Low PSI Check Valves

Replace assembly part # ending '-00' to order 4PSI or 15PSI check valves



4 PSI
'-P4'
[BLUE]

10 PSI
'-00'
[Standard]

15 PSI
'-P15'
[RED]

Triple Outlet Square Lug Nozzle Bodies

Robust and cost effective nozzle bodies for sprayers to switch up to three nozzles by simply rotating the outlet. Safer and easier than handling contaminated nozzles.

Boom Pipe	Outlets	Style	Part#
3/4" (0.84" OD)	3 Square Lug	Check Valve	40653-00
		No Check	40140-00
1" (1.315" OD)	3 Square Lug	Check Valve	40663-00
		Manual On/Off	40663-MS
		No Module	40663-NM
		No Check	40141-00



40663-00
Triple Swivel
Combo-Jet



40663-NM
Triple Swivel
w/o Check Valve

Commonly used to cost effectively retrofit a sprayer to a PWM spray system

1" KWIKSTOP™ Square Lug Nozzle Bodies

Nozzle bodies with raised inlets to passively purge air trapped at the top of a sprayer boom pipe, reducing nozzle run-on & improving boom shut-off response times.

Boom Pipe	Outlets	Style	Part#
1" (1.315" OD)	1 Square Lug	KWIKSTOP	40671-00
	2 Square Lug	KWIKSTOP	40672-00
	3 Square Lug	KWIKSTOP	40673-00



40671-00
Single w/
KWIKSTOP
Raised inlet



40672-00
Dual Swivel
w/ KWIKSTOP
Raised Inlet

Swivel Body Replacement Parts - For ALL TYPES Swivel Bodies

- 40166-04 O-ring Repair Kit, CJ Nozzle Bodies, FKM (6 Bodies)
- 40166-05 O-ring Repair Kit, CJ Nozzle Bodies, VITON® (6 Bodies)
- 40193-02 SCREW, Hi-Lo, #10 x 3/4" SS [for Hinged Swivel Bodies]
- 40155-23 Molded Diaphragm, FKM (replaces 40155-07 + 20455-04)
- 20455-07 O-ring, 3/8" inlet seal, #110, FKM, Duro 70
- 20455-04 O-ring, Pressure Pad, Replacement (pairs with 40155-07)
- 40155-07 Diaphragm Rubber Seal, EPDM (use w/ #20455-04)
- 40155-12 Diaphragm Rubber Seal, VITON® (use w/ #20455-04)

3/8" Nozzle body inlet o-ring



20455-07



Hi-Lo screw for Swivel Bodies

40193-02

CJ Nozzle Body Repair Kits* (up to 6 bodies)

- | | |
|-----------------------------------|-----------------|
| BUNA-N Kit incl. | viton Kit incl. |
| 6x Pressure Pad O-rings #20455-04 | #20455-V4 |
| 24x Inner-body O-rings #40155-09 | #40155-13 |
| 6x Diaphragms #40155-07 | #40155-12 |

*Kits will include either a pair of #20455-04 & #40155-07, or #40155-23. Both serve the same function.

NEW



40155-23
Requires pressure pad o-ring to be removed



20455-04
*Also requires 20455-04 pressure pad o-ring



PRODUCT UPGRADE: Diaphragms

A molded, single-piece diaphragm is replacing the two-piece diaphragm rubber + pressure pad o-ring.



For replacing old-style parts, ENSURE pressure pad o-ring is removed from check valve module, and the new diaphragm groove fits where the pressure-pad o-ring was.

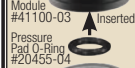

Replaced by Single-Piece Molded Diaphragm



*May be black, red or brown (viton)

Square Lug Nozzle Body Accessories - Only for Square Lug Nozzle Body Outlets (Teejet, Hypro, etc)

Plug Cap



40180-05
Caps Square Lug nozzle outlets

3/8" Slot



40159-05
For 3/8" wide flanged spray tips

Threaded Cap



40164-00
45° 1/4" NPT-F thread

Flanged Strainers



40150-00 [50 Mesh]
40151-00 [100 Mesh]
Stainless Steel Strainers for Square Lug Outlets

Cap Gaskets



40160-00 [FKM]
40160-V0 [viton]

Gaskets are required to seal all Square Lug Caps

COMBO-RATE® Stacking Nozzle Bodies

W
E
T

B
O
O
M

The COMBO-RATE® Advantage

Debris-cleaning inlet slots for less residue buildup

Hinged Clamp for easy install

Two-Way Nozzle Bodies can reverse left/right for universal mounting

U-clip fittings can be easily retrofitted to use any future COMBO-RATE products

High flow bodies with low pressure-drop

Bodies can be equipped with any combination of control modules, including AIR-OFF, PWM solenoid, Manual ON/OFF or spring-based diaphragm check valves

Ability to spray with multiple nozzles simultaneously OR reserve integrated nozzle body for fertilizer top dressing

KWIKSTOP® Raised Inlet Available

COMBO-RATE® Side-fed Saddles

Robust side-fed saddles mount with a inlet hole on the side of a sprayer boom, with a female combo-clip port for CR bodies



Boom Size	Inlet Size	Part#
3/4" Pipe (1.05" OD)	3/8" inlet	41203-00
1" Pipe (1.315" OD)	3/8" inlet	41200-00
1" Pipe (1.315" OD)	9/16" inlet	41201-00
2" Pipe (2.375" OD)	9/16" inlet	41206-00

COMBO-RATE® II Top or Bottom-fed Saddles

Combo-Rate II saddles can be fed with an bottom inlet or flipped and fed from a hole in the top of a boom pipe to passively purge air trapped in a sprayer boom.



One-Way Stacking Saddles

Boom Size	Inlet Size	Part#
1/2" Pipe (0.84" OD)	3/8" inlet	41471-00
1" Pipe (1.315" OD)	3/8" inlet	41475-00
1" Pipe (1.315" OD)	9/16" inlet	41477-00
1" Pipe (1.315" OD)	21/32" inlet	41479-00

Two-Way Stacking Saddles

Boom Size	Inlet Size	Part#
1/2" Pipe (0.84" OD)	3/8" inlet	41472-00
1" Pipe (1.315" OD)	3/8" inlet	41476-00
1" Pipe (1.315" OD)	9/16" inlet	41478-00

COMBO-RATE® II Integrated Nozzle Bodies

One-Way Stacking Integrated COMBO-RATE® II Nozzle Bodies

One-way stacking COMBO-RATE nozzle bodies stack to the left with one open u-clip port. Typically using a manual on/off module, these bodies can be used to spray separately than turrets/bodies or simultaneously from multiple nozzles. Multiple nozzle spraying can be an effective way to improve coverage in high volume applications to make a more meaningful mix of droplets.



KWIKSTOP®
Raised Inlets
Naturally aspirate
the boom, reducing
nozzle run-on

HOW THEY WORK: Manual ON/OFF Check Valves

Since Combo-Rate nozzle bodies stack, a manual way to turn off flow to certain outlets is required.

When the knob is **OPEN**, it acts as a standard 10 PSI check valve.
When the knob is **CLOSED**, it turns off flow to that nozzle outlet **ONLY**. It does not effect other stacked nozzle bodies.



Nozzle Body Specifications

Operating Pressure	10*-125PSI
3/8" Inlet Single Outlet Flow Rate	2.1 us gpm @ 5PSI pressure drop 3.1 us gpm @ 10PSI pressure drop
9/16" Inlet Single Outlet Flow Rate	2.2 us gpm @ 5PSI pressure drop 3.5 us gpm @ 10PSI pressure drop
21/32" Inlet High Flow Single Outlet Flow Rate	3.0 us gpm @ 5PSI pressure drop 4.0 us gpm @ 10PSI pressure drop
O-ring Seals	FKM (viton avail.)
Materials	SS (screws) Glass-Reinforced Polypropylene (body)

* 10PSI minimum with 10PSI check valve

Boom Size	Sch40 Pipe Outside Diameter	Inlet Size	Stacking Direction	Nozzle Bodies with 5/16" Bolt Mount Upper Clamp			
				Module Description & Part#			
				Dia. Check Valve	Manual ON/OFF	Air-Off Operated	PWM (w/o Nut)**
1/2"	0.84"	3/8" Inlet	One-Way	41411-00	41413-00	41415-00	41417-00
3/4"	1.05"	3/8" Inlet	One-Way	41421-00	41423-00	41425-00	41427-00
28mm	28mm	3/8" Inlet	One-Way	41481-00	41483-00	41485-00	41487-00
1"	1.315"	3/8" Inlet	One-Way	41431-00	41433-00	41435-00	41437-00
		9/16" Inlet	One-Way	41441-00	41443-00	41445-00	41447-00
1" KWIKSTOP	1.315"	3/8" Inlet	One-Way	41451-00	41453-00	41455-00	41457-00

Two-Way Stacking Integrated COMBO-RATE® II Nozzle Bodies

Two-way stacking COMBO-RATE nozzle bodies stack to both directions, with two open u-clip ports. Typically using a manual on/off module, these bodies can be used to spray separately than turrets/bodies or simultaneously from multiple nozzles. Multiple nozzle spraying can be an effective way to improve coverage in high volume applications to make a more meaningful mix of droplets.

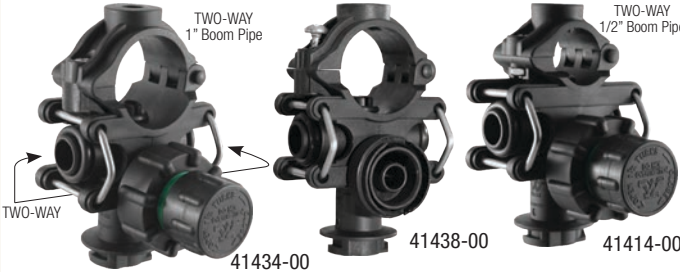

High Flow Nozzle Bodies

For very high flow requirements, use the 21/32" inlet size nozzle bodies.



Stacked Outlet Specification

Operating Pressure	10*-125PSI
3/8" Inlet Two Outlets Used Flow Rate	3.2 us gpm @ 5PSI pressure drop 5.0 us gpm @ 10PSI pressure drop
9/16" Inlet Two Outlets Used Flow Rate	3.6 us gpm @ 5PSI pressure drop 6.2 us gpm @ 10PSI pressure drop
21/32" Inlet High Flow Two Outlets Used Flow Rate	4.6 us gpm @ 5PSI pressure drop 9.0 us gpm @ 10PSI pressure drop
O-ring Seals	FKM (viton avail.)
Materials	SS (screws) Glass-Reinforced Polypropylene (body)

* 10PSI minimum with 10PSI check valve

Boom Size	Sch40 Pipe Outside Diameter	Inlet Size	Stacking Direction	Nozzle Bodies with 5/16" Bolt Mount Upper Clamp			
				Module Description & Part#			
				Dia. Check Valve	Manual ON/OFF	Air-Off Operated	PWM (w/o Nut)**
1/2"	0.84"	3/8" Inlet	Two-Way	41412-00	41414-00	41416-00	41418-00
3/4"	1.05"	3/8" Inlet	Two-Way	41422-00	41424-00	41426-00	41428-00
28mm	28mm	3/8" Inlet	Two-Way	41482-00	41484-00	41486-00	41488-00
1"	1.315"	3/8" Inlet	Two-Way	41432-00	41434-00	41436-00	41438-00
		9/16" Inlet	Two-Way	41452-00	41454-00	41456-00	41458-00
1" High Flow	1.315"	21/32" Inlet	Two-Way	41442-00	41444-00	41446-00	41448-00
1" KWIKSTOP	1.315"	3/8" Inlet	Two-Way	41462-00	41464-00	41466-00	41468-00

Combo-Rate Body & Turret Replacement Parts

- 40200-02 O-ring, CR Inter-body, #206, FKM
- 20455-07 O-ring, 3/8" Nozzle Body Inlet Stem, #110, FKM
- 40200-02 O-ring, 9/16" Nozzle Body Inlet Stem, #206, FKM
- 41361-02 O-ring, 21/32" Nozzle Body Inlet Stem, #115, FKM
- 20460-04 U-clip, 304SS
- 41331-03 Screw, HiLo, SS, CR II Body Hinge Clamp Screw (for 2016+ newer)
- 41285-00 Adapter, CR Plug [Covers unused Combo-Rate port]
- 41502-04 CR Turret Outlet Arm, Combo-Jet Outlet
- 41502-10 CR Turret Outlet Arm, Square Lug Outlet
- 41502-13 CR Turret Outlet Arm, Double-Down Combo-Jet Outlet
- 41502-05 CR Turret Outlet Arm, Plug
- 40155-23 Diaphragm, Molded, FKM (Replaces #40155-07 + 20455-04)
- 41100-15 CR II Nozzle Body O-ring Repair Kit, FKM (6 Bodies)
- 41100-16 CR II Nozzle Body O-ring Repair Kit, VITON® (6 Bodies)
- 41502-11 CR Turret Repair Kit, FKM (2 Bodies)
- 41502-12 CR Turret Repair Kit, VITON® (2 Bodies)



COMBO-RATE®
Turret Repair Kits
(For up to 2 turrets):

- 10x Turret Outlet O-rings #20455-07
- 4x Turret Core O-rings #41502-06
- 2x Diaphragm #40155-07
- 2x Combo-Jet Outlet Arm #41502-04
- 2x Turret Plugs #41502-05
- 2x Turret Lock Clips #41502-09

COMBO-RATE® II
Body Repair Kits*
(For up to 6 bodies):

- 6x Pressure Pad O-rings #20455-04
- 6x Inter-body O-rings #40200-02
- 6x Diaphragms #40155-07

*Repair kits may include a pair(s) of #40155-07 and #20455-04, or a single #40155-23. Both serve the same purpose. Ensure to remove the pressure pad o-ring if #40155-23 is being used.

* Requires #20455-07 O-Ring

COMBO-RATE® Stacking Thru & End Bodies

COMBO-RATE® Thru Bodies

Thru bodies stack onto any existing combo-clip female port and adds an additional combo-clip male port for further expansion.



COMBO-RATE Thru Body [Connects to any Combo-Rate female ports]			
Dia.Check Valve	Manual ON/OFF	Air-Off Operated	PWM (w/o nut)**
41100-00	41110-00	41125-00	41135-00

COMBO-RATE® End Bodies

End bodies stack onto any existing combo-clip female port to add a nozzle body that can be equipped for any spraying needs.

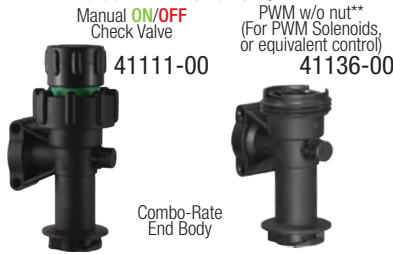

COMBO-RATE End Body [Connects to any Combo-Rate female ports]			
Dia.Check Valve	Manual ON/OFF	Air-Off Operated	PWM (w/o nut)**
41101-00	41111-00	41126-00	41136-00

CR Swivel End Bodies

End bodies that can be adjusted (via interior screw) in 15° increments for fence-row & crop adapted spraying applications.



COMBO-RATE End Body [Connects to any Combo-Rate female ports]			
Dia.Check Valve	Manual ON/OFF	Air-Off Operated	PWM (w/o nut)**
41102-00	41112-00	41127-00	41137-00

Combo-Rate Stacking Body Specification

Operating Pressure 10"-125PSI	O-ring Seals FKM (viton avail.)	Materials Glass-reinforced Polypropylene	Flow Rate 2.1 us gpm (end & thru), 1.6 us gpm (swivel body)
----------------------------------	------------------------------------	---------------------------------------------	----------------------------------------------------------------

COMBO-RATE® Turrets

The COMBO-RATE® Turret Advantage

Common U-clip connections for all Combo-Rate parts

Each turret arm is o-ring sealed to keep out dust & debris

Module threads are compatible with most PWM spray systems

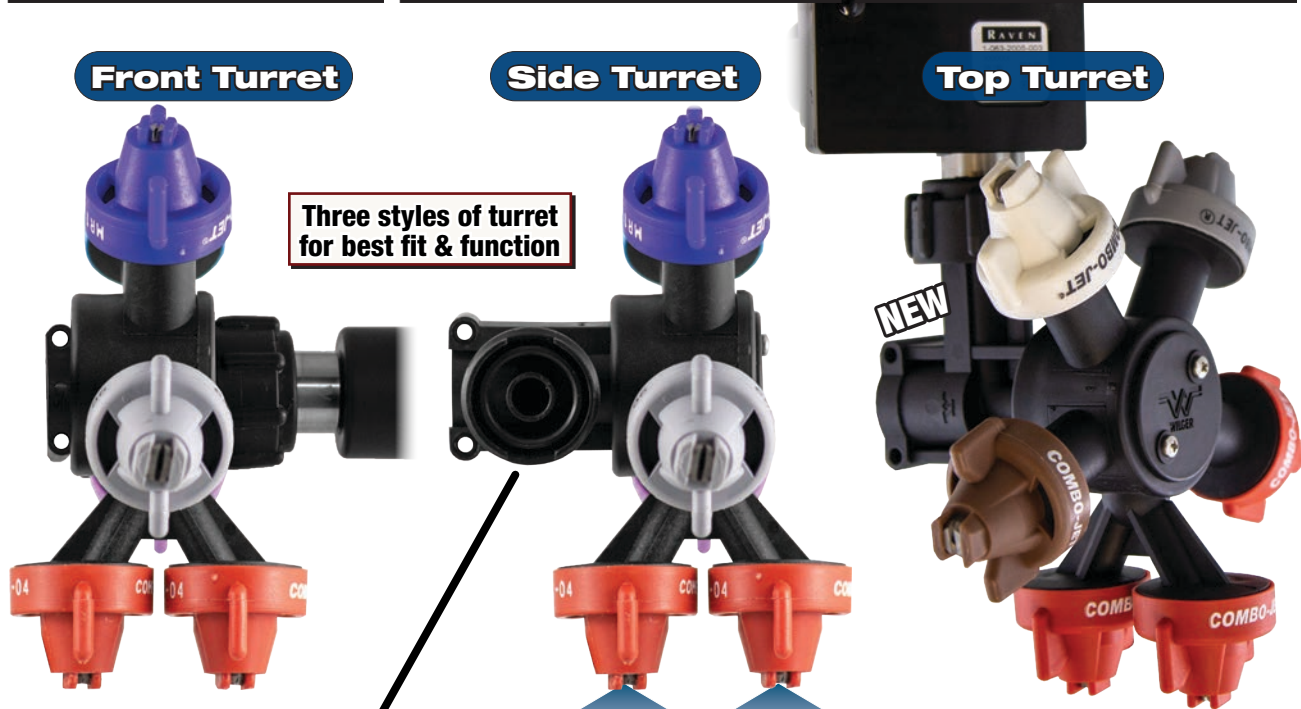

Three styles of turret for best fit & function

Bodies can be equipped with any combination of control modules, including AIR-OFF, PWM solenoid, Manual ON/OFF or spring-based diaphragm check valves

Multiple options for Single CJ, Square Lug, or Double-Down outlets

Double-Down Turrets allow for dual nozzle spraying for better overage in high volume & fungicide applications

COMBO-RATE turrets provide you customized options for any desired turret configuration, allowing it to be a universal turret for any brand of sprayer or nozzles.

COMBO-RATE® Stacking Component Examples

COMBO-RATE® Side-Fed Saddles



COMBO-RATE® II (CRII) Top/Bottom-Fed Saddles



COMBO-RATE® II Bottom-Fed Nozzle Body



COMBO-RATE® Stacking Components



COMBO-RATE® Turrets - cont'd

Sprayers have different nozzle requirements, due to spacing, boom frame design & interference, so Wilger has three styles of turrets that can be used to fit any situation.

COMBO-RATE Front Turrets

Front turrets stack onto any COMBO-RATE nozzle body, mounting on the common u-clip port. Turrets are available in a variety of outlet and module styles, which are mounted onto the 'front' face of the turret.

Number of Outlets	Description & Part #			
	Dia. Check Valve	Manual ON/OFF	Air-Off Operated	PWM (w/o nut)*
3 CJ Outlet	41503-00	41513-00	41543-00	41533-00
4 CJ Outlet	41504-00	41514-00	41544-00	41534-00
5 CJ Outlet	41505-00	41515-00	41545-00	41535-00
3 CJ Outlet + 2 SQ Lug Outlet	41505-32*	41515-32*	41545-32*	41535-32*
Double-Down + 4 CJ Outlet	41506-00	41516-00	41546-00	41536-00



HOW THEY WORK: Manual ON/OFF Valves

Since Combo-Rate nozzle bodies stack, a manual way to turn off flow to certain outlets is required.



When the knob is **OPEN**, it acts as a standard 10 PSI check valve.

When the knob is **CLOSED**, it turns off flow to that nozzle outlet ONLY. It does not effect other stacked nozzle bodies.

Module Installation & Re-installation

During installation, ensure knob is in OPEN orientation. Otherwise the binding nut cannot seal the nozzle body. Ensure the orientation tabs (green) are seated properly.

COMBO-RATE Side Turrets - Reversible

Side turrets stack onto any COMBO-RATE nozzle body, mounting on the common u-clip port. Turrets are available in a variety of outlet and module styles, which are mounted onto the side of the turret with a reversible module stem.

Number of Outlets	Description & Part #			
	Dia. Check Valve	Manual ON/OFF	Air-Off Operated	PWM (w/o nut)*
3 CJ Outlet	41603-00	41613-00	41643-00	41633-00
4 CJ Outlet	41604-00	41614-00	41644-00	41634-00
5 CJ Outlet	41605-00	41615-00	41645-00	41635-00
3 CJ Outlet + 2 SQ Lug Outlet	41605-32	41615-32	41645-32	41635-32
Double-Down + 3 CJ Outlet	41606-00	41616-00	41646-00	41636-00



Reversing Orientation

Switch a side turret module stem from left to right in seconds. No extra parts required.

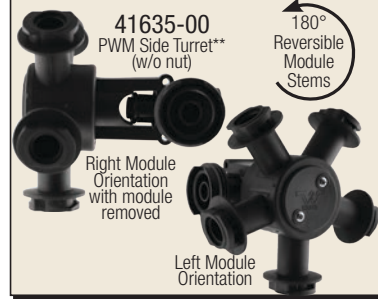

41602-07 Side-Turret Core Replacement kit for Teejet/Hypro Threaded PWM Solenoid
41602-09 Side-Turret Core Replacement kit for Arag Threaded PWM Solenoid

NEW COMBO-RATE Top Turrets

Top turrets stack onto any COMBO-RATE nozzle body, mounting on the common u-clip port. Turrets are available in a variety of outlet and module styles, which are mounted onto the top of the turret. Ideal for use with bulky PWM solenoids in tight booms.

Number of Outlets	Description & Part #			
	Dia. Check Valve	Manual ON/OFF	Air-Off Operated	PWM (w/o nut)*
3 CJ Outlet	41803-00	41813-00	41843-00	41833-00
4 CJ Outlet	41804-00	41814-00	41844-00	41834-00
5 CJ Outlet	41805-00	41815-00	41845-00	41835-00
3 CJ Outlet + 2 SQ Lug Outlet	41805-32	41815-32	41845-32	41835-32
Double-Down + 4 CJ Outlet	41806-00	41816-00	41846-00	41836-00



41835-00 No Nut (for PWM Solenoid)

NEW Double-Down Turrets

Double nozzles from a single turret outlet. Great for double-down PWM spraying.

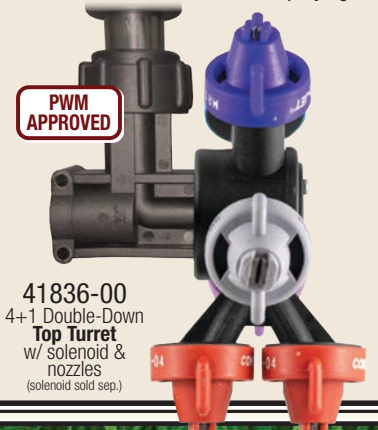

41836-00 4+1 Double-Down Top Turret w/ solenoid & nozzles (solenoid sold sep.)

Increasing Coverage with Crop-Adapted Spraying

Different crops require different kinds of spray coverage for best efficacy, so changing how spray is deposited can often provide beneficial results in both coverage and application efficacy. It starts with adapting how the crop is being targeted, ensuring maximizing spray deposition on the target area, and minimizing spray on less-ideal or wasted areas.

For example, using two spray tips **straight down** can provide better penetration through thick canopies, allowing for better interior canopy coverage; while two angled spray patterns **forward & backward** can lend to spray coverage at the top canopy foliage or on both front/back of a cereal head.

Why use two nozzles straight down, and not a multi-angle spray tip?

Further distance to target can mean less canopy penetration with angled

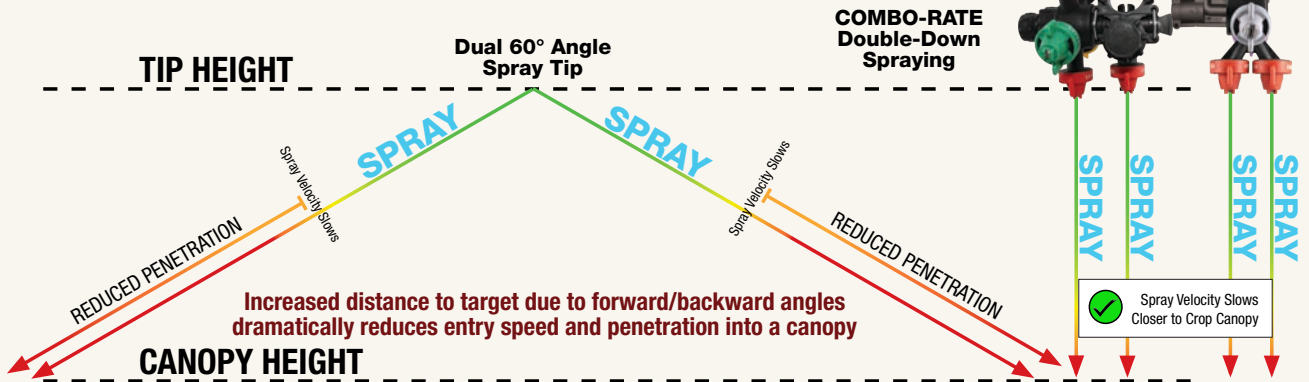

COMBO-RATE gives you better penetration and coverage for a more consistent application into thick canopy crops.

Examples of Tough to Penetrate Crop Canopies

Options for Double-Down Spraying

Stacked bodies	Double-Down Adapters	Double-Down Turrets
	#40206-00 for Teejet Bodies	#40441-00 for Wilger Bodies



Picking Nozzles for Double-Down Spraying?

Applicators often already have nozzles to be used in pairs for double down spraying. E.g. 5 + 10 gal/acre nozzles could be used for 15 gal/acre. Visit the dual tip spraying guide in the catalog for more info.

What about spraying vertical targets that don't have a dense canopy?

Angled spray for vertical growing targets (e.g. cereal heads) can provide superior coverage

Spraying a vertical target is different than spraying into a canopy. Spraying forward/backward with a nozzles produces spray that can travel horizontal, making it more effective to cover vertical targets at suitable boom heights.

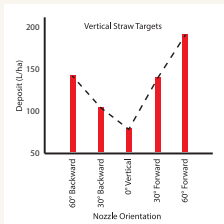

COMBO-RATE® Nozzle Body with #40440-00 Wye Splitter

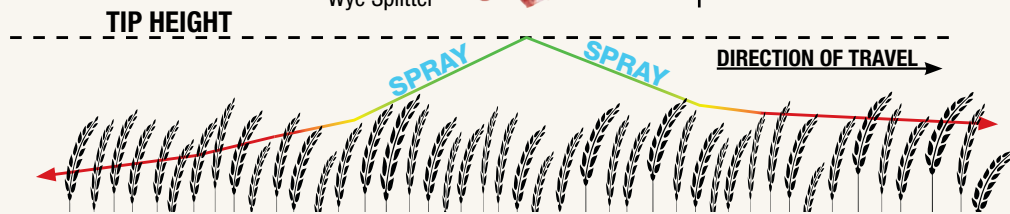

Vertical Target Spraying e.g. Applying Fungicide on Wheat

Dry Boom Nozzle Bodies & Accessories

Compact Nozzle Bodies

Compact Bodies have many uses, as inline check valves on planting equipment, estate sprayers, dry boom nozzle bodies, or other situations that would require a compact check valve with a Combo-Jet cap outlet.

Outlet Adapter



40498-00
3/8" NPT-F
inlet

Inlet	Part #
1/4"	40497-00
3/8"	40498-00

Adapts a threaded port to a Combo-Jet outlet

1/4" Push-in Tube Bodies



40502-NM
*solenoid or control module must be used on -NM assemblies



40502-00
1/4" Quick Connect inlet

Inlet (O.D.)	10PSI Check	4PSI Check	No Module
1/4"	40502-00	40502-P4	40502-NM

Adapts a 1/4" O.D. tube inlet to a Combo-Jet outlet

Threaded Inlet Bodies



4PSI Check Valve (Blue)

1/4" bolt mount



40501-00
1/4" NPT Female Inlet

Thread	10PSI Check	4PSI Check	No Module
1/8" NPT-F	40500-00	40500-P4	40500-NM
1/4" NPT-F	40501-00	40501-P4	40501-NM

Adapts a female thread inlet to a Combo-Jet outlet

5/8" Square-Mount Dry Boom Swivel Nozzle Bodies with 3/8" NPT-F feed

Square-Mount nozzle bodies attach to a boom frame with 5/8" square mounts, and are fed by a 3/8" NPT-F inlet.

Add a 3/8" NPT hose shank adapter
40311-00



40352-00

COMBO-JET Square-Mount Bodies



40352-00



40353-00



40354-00

Outlets	Part #
Single CJ	40352-00
Dual CJ	40353-00
Triple CJ	40354-00

Square Lug Square-Mount Bodies



Square Lug Outlets (Teejet/Hypro/etc.) with dust shield



40152-00



40153-00

Outlets	Part #
Dual Sq. L	40152-00
Triple Sq. L	40153-00

3/8" NPT-M Hose Shank Adapters



40311-00



40312-00



40313-00

Fitting	One-Way	Two-Way	Three-Way
3/8" HB x 3/8" NPT-M	40301-00	40302-00	-
1/2" HB x 3/8" NPT-M	40306-00	40307-00	-
3/4" HB x 3/8" NPT-M	40311-00	40312-00	40313-00

Combo-Jet Outlet Swivel Turret Adapters

Turret Adapters intended for slow movement activities without risk of being struck



40471-00



40470-00



40473-00



40472-00

Swivel Outlets	Dual Turret	Triple Turret
Combo-Jet Outlet	40470-00	40471-00

Swivel Outlets	Dual Turret	Triple Turret
Square Lug Outlet	40472-00	40473-00

High Mount Dry Boom Nozzle Bodies with Hose Shank Feed

High Mount Flange

Flange Mount bodies mount right above the nozzle outlet with a round hole with notches cut for orientation



40461-00



3/8" HB

1/4" NPT-M

40464-00

Inlet(s)	One-Way	Two-Way
3/8" Hose Barb	40460-00	40461-00
1/2" Hose Barb	40462-00	40463-00
3/8" HB x 1/4" NPT-M	-	40464-00

Flange Top View

5/8" Square Mount Nozzle Bodies

5/8" Square Mount nozzle bodies attach to a clamp with a 5/8" square mount



40451-00



40450-00

Inlet(s)	One-Way	Two-Way
3/8" Hose Barb	40450-00	40451-00
1/2" Hose Barb	40452-00	40453-00
3/8" HB x 1/4" NPT-M	-	40454-00

Sq Mt w/o check

Square Mount Compact Bodies without check valves



40406-00

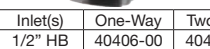

40407-00

Inlet(s)	One-Way	Two-Way
1/2" HB	40406-00	40407-00

5/8" Square Mount Stainless Steel Clamps

Wilger manufactures a series of 5/8" square mount clamps that are used with compatible nozzle bodies. Refer to the CLAMPS pages to find the full listing of available stainless steel clamps



Dry Boom Nozzle Bodies & Accessories - cont'd

Rotating Adjustable Swivel Bodies & Hose Drop Assemblies

Hose Drop Adapters

Nylon hose drops are used to feed bodies to spray down below a canopy to minimize crop contact

Hose Drop Adapters

Inlet	Outlet	Length	Part #
1/4" NPT-M	1/4" NPT-M	16"	22021-00
		24"	22031-00
		36"	22037-00
		48"	22047-00
	1/4" NPT-F	16"	22025-00
		24"	22035-00



Hose Drop & Extension Caps

Outlet	Length	Part #
Combo-Jet to Combo-Jet	2"	40210-00
	5"	40211-00
Combo-Jet Cap to 1/4" NPT-M	16"	22026-00
	24"	22036-00
	36"	22038-00
	48"	22048-00



Adjustable Swivel Bodies [360° Lockable Rotation Front/Back]

Swivel Bodies can be rotated front to back 360° use for Crop Adapted Spraying or other targeting



Inlet Size	Outlet(s)	Control Modules		
		Without Dia.	Dia. Check	Manual On/Off
1/4"	Single	40225-00	40231-00	40237-00
	Double	40226-00	40232-00	40238-00
1/4" NPT-M	Single	40227-00	40233-00	40239-00
	Double	40228-00	40234-00	40240-00
1/4" NPT-M w/ 1/4" NPT-F	Single	40229-00	40235-00	40241-00
	Double	40230-00	40236-00	40242-00
3/8" HB w/ 5/8" Sq. Mount	Single	40243-00	40244-00	40245-00

Crop Adapted Spraying

Using adjusted nozzle angles, swath and direction to better adapt to specific crop targets to maximize efficacy or minimize risk

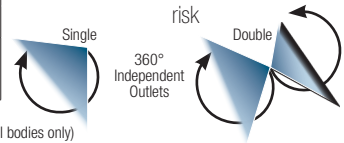

40237-03 ... Diaphragm Manual Shut-off Assembly, Replacement (for adjustable swivel bodies only)

Low-Mount Compact Bodies - Contact Factory for availability. (Non-stocked item)

11/16" Thread Mount Low Mount Bodies

A low mounting compact body that attaches to a sprayer boom frame with an 11/16" threaded nut.



Inlet Size	One-Way [Left]	One-Way [Right]	Two-Way
3/8" HB	40360-00	40361-00	40362-00
1/2" HB	40365-00	40366-00	40367-00
3/4" HB	40370-00	40371-00	40372-00

40155-21 Module Retainer, Replacement
40199-00 Lock Nut, 11/16" Thread

5/8" Square Mount Low Mount Bodies

A low mounting compact body that attaches to a sprayer boom frame with an common 5/8" square mounting port.



Inlet Size	One-Way [Left]	One-Way [Right]	Two-Way	Three-Way
3/8" HB	40380-00	40381-00	40382-00	40383-00
1/2" HB	40385-00	40386-00	40387-00	40388-00
3/4" HB	40390-00	40391-00	40392-00	N/A

40155-21 Module Retainer, Replacement

COMBO-RATE Boomless Sprayer Manifold Assemblies

Boomless sprayers are used to spray areas not accessible by traditional boomed sprayers, such as ditches, roadways, pastures, and commercial/industrial areas.

COMBO-RATE boomless sprayers can be configured in hundreds of ways depending on mounting, size, and flow requirement.

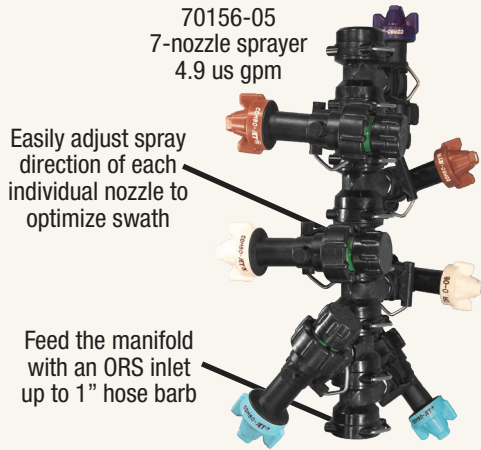

Example Assembly	Flow Rate (us gal/min)	Part#
3-Nozzle Boomless Spraying Manifold	1.3 us gal/min	70154-01
	2.6 us gal/min	70154-03
	5.8 us gal/min	70154-06
5-Nozzle Boomless Spraying Manifold	2.3 us gal/min	70155-02
	2.9 us gal/min	70155-03
	5.8 us gal/min	70155-06
	11.5 us gal/min	70155-12
7-Nozzle Boomless Spraying Manifold	3.9 us gal/min	70156-04
	4.9 us gal/min	70156-05
	9.6 us gal/min	70156-10
	19.5 us gal/min	70156-20

Adjustable swath distance charts online



Easy-to-follow charts are online to help you figure out how to get the swath distance for your application needs.

Find them at www.WILGER.NET

Stainless Steel Clamps for Sprayer & Liquid Fertilizer Appl.

5/8" Square Mount Clamps

5/8" Square Mount clamps attach a nozzle body with 5/8" square mount to a tube or pipe

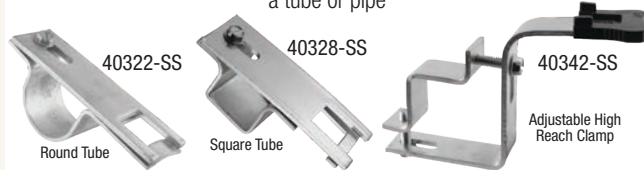

Mount Size	Standard 5/8" Square Mount Clamp (SS)		Adjustable High-Reach 5/8" Square Mount Clamp (SS)
	for Round Tube	for Square Tube	
1/2"	40320-SS	N/A	3/4" Tube Extra High Reach
3/4"	40321-SS	40325-SS	40343-SS
1"	40322-SS	40326-SS	3/4" to 1-1/4"
1-1/4"	N/A	40327-SS	40341-SS
1-1/2"	N/A	40328-SS	1-1/2" to 2"
2"	N/A	40330-SS	40342-SS

Two-Hole Bolt-Mount Clamps for Sq. Tube

Two-Hole Clamps for Flow Indicator, Manifold, & Nozzle Body Mounting



Size	Part#
1"	40550-SS
1-1/4"	40551-SS
1-1/2"	40552-SS

Three-Hole Bolt-Mount Clamps for Sq. Tube

Three-Hole Clamps for Sprayer Boom Tube, Nozzle Body & Utility Mounting
Boom tube clamps are sold in halves, so two are required for proper use.

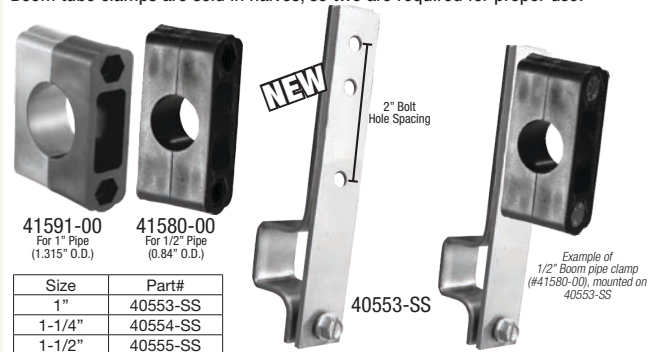

Size	Part#
1"	40553-SS
1-1/4"	40554-SS
1-1/2"	40555-SS

3/4" Square Mount Clamps for Nozzle Bodies

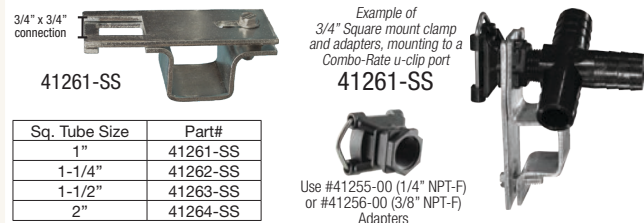

Sq. Tube Size	Part#
1"	41261-SS
1-1/4"	41262-SS
1-1/2"	41263-SS
2"	41264-SS

Nozzle Body Accessories & Replacement Parts

Combo-Rate Control Modules & Nuts

Wilger manufactures a few styles of control modules that can be swapped between any Combo-Rate or Combo-Jet nozzle bodies

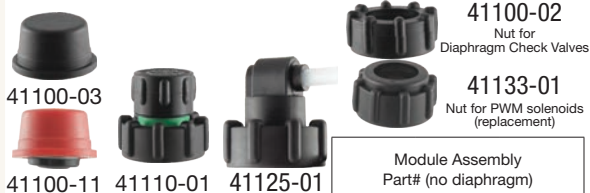

Check Valve Type	Extra Information	10 PSI (Standard)	4 PSI (Blue Knob)	15 PSI (Red Knob)
Diaphragm	Drip check, use 41100-02 nut	41100-03	41100-12	41100-11
Manual ON/OFF	In "Off" position, closes check valve (no flow)	41110-01	41110-07	41110-08
Air-OFF	When air is applied, closes check valve (no flow)	41125-01	-	-

* Recommended to apply 20PSI more than spray pressure for ideal operation & quick shut-off

Inter-body Strainers

Inter-body strainers are used in-between Combo-Rate nozzle bodies to catch burrs or debris during the break-in period of new sprayers, or to further protect PWM solenoids



Strainer Mesh	Part#
50 Mesh	41150-00
80 Mesh	41152-00
100 Mesh	41151-00

Diaphragm Seals

Rubber Diaphragms are used in ALL control modules to seal the flow within the check valve

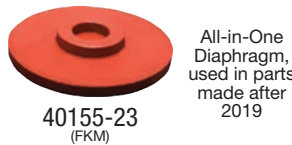

The bottom of the control modules have a groove for a pressure pad o-ring or all-in-one diaphragm



Two-piece diaphragm & pressure pad o-ring

Diaphragm	Pressure pad O-Ring
40155-07 (EDPM)	20455-04 (Buna-N)
40155-12 (viton)	20455-V4 (viton)

Either rubber diaphragm can be typically used, but ensure to replace diaphragm in proper orientation and remove pressure pad o-ring if 40155-23 diaphragm is used.

O-ring Seals

O-ring seals are commonly used on many component parts.

FKM material is standard, viton is available.

O-ring	Description/Where Used	FKM#	VITON #
13mm x 3mm	COMBO-JET spray tips	40260-00	40260-V0
#009	CR Top-turret faceplate	41802-04	40802-V4
#015	ORS Metering orifices	40225-04	40225-05
#106	9/16" Nozzle body inlet	51204-04	51204-V4
#108	Module pressure pads	20455-04	20455-V4
#110	3/8" Nozzle body inlet	20455-07	20455-V7
#115	21/32" Nozzle body inlet	41361-02	41361-V2
#116	1/2" QN100 connections	25120-02	25120-V2
#118	ORS Strainer cartridges	-	20576-V4
#119	EFM Sensor housing seal	20580-12	20580-13
#121	CR Turret core seals	41502-06	41502-V6
#203	5/16" Push-In Tube O-ring	20457-03	20457-V3
#206	CR Stacked body side seal	40200-02	40200-V2
#212	O-ring Seal (ORS) fittings	20460-03	20460-15
#214	Boom end flush valve core	-	25175-08
#219	QN100 O-ring seal	25160-02	25160-V2

Air Tees & Reducers

Tees and Reducers that can be used to couple tube for air or liquid supply



Fitting Type	Description	Part#
Tee	3/8" x 3/8" x 1/4" O.D.	20455-00
	5/16" x 5/16" x 1/4" O.D.	20457-00
Reducer	3/8" x 1/4" O.D.	20456-00

Estate Sprayer Manifolds, Accessories & Adapters

Estate Sprayer Manifold Assemblies

Wilger manifold assemblies are pre-built manifolds based on common requirements. COMBO-RATE components can be used to expand or change any manifold.

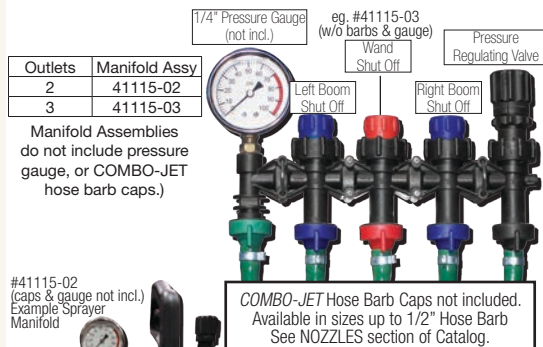

Outlets	Manifold Assy
2	41115-02
3	41115-03

Manifold Assemblies do not include pressure gauge, or COMBO-JET hose barb caps.)

#41115-02 (caps & gauge not incl.) Example Sprayer Manifold

COMBO-JET Hose Barb Caps not included. Available in sizes up to 1/2" Hose Barb See NOZZLES section of Catalog.



Manifolds can also be built with O-Ring Seal (ORS) Fittings

Connection	Pressure Regulating Valve	Manual On/Off Check Valve	1/4" NPT-F for Pressure Gauge
Thru Body	41130-00	41110-00	-
End Body	41131-00	41111-00	-
Combo-Clip Male	-	-	-
End Body	-	-	41251-00
Combo-Clip Female	-	-	-

Combo-Clip (CC) Adapters & 3/4" Sq. Mount Clamps

Combo-Clip connections are compatible with all Combo-Rate Fittings and Nozzle Bodies

Connection	Outlet	Part #
Combo-Clip Male	Plug	41285-00
	1/4" NPT-F	41275-00
	3/8" NPT-F	41276-00
Combo-Clip Female	1/4" NPT-F	41251-00
	1/4" NPT-M	41252-00
	3/8" NPT-M	41253-00
	90° CC-M	41250-00
Combo-Clip Female w/ 3/4" Sq Mount	1/4" NPT-F	41255-00
	3/8" NPT-F	41256-00

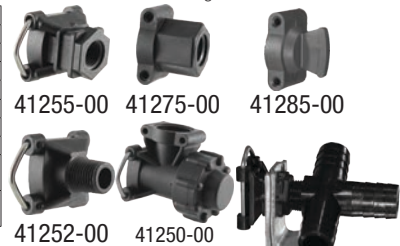

Clamps for 3/4" Square-Mount Adapters

Square Tube Size	3/4" Sq. Mount Nozzle Body Clamps
1"	41261-SS
1-1/4"	41262-SS
1-1/2"	41263-SS
2"	41264-SS

Combo-Clip Adapters can be used to convert a traditional dry boom sprayer to use cutting edge COMBO-RATE turrets & fittings

Regulating & Manual On/Off Manifold Valves

Pressure Regulating Valves Open or close to regulate how much flow is bypassed back to tank to regulate pressure. Lock washer is used to hold position

When in 'ON' position, acts as a 10PSI drip check. When in 'OFF' position, it turns off flow to the outlet



41130-00

41131-00

41110-00

41111-00

41251-00

Ensure to visit the NOZZLES section of the catalog for the full listing of Combo-Jet Caps

Wilger 1/2" & 1" Stainless Steel Tube - For QN100 & QF100 Fittings

Wilger Stainless Steel Tubing is engineered for high performing modern sprayers. The high flow sprayer boom tube shares outside dimensions of commonly used sch40 pipe, but the light weight design minimizes weight in the field. Custom tube lengths, spacing and inlet holes are available by order.



Larger Inside Diameter
Inside diameter is larger to accommodate higher flow rates

Rolled End for Cost-Effective Manufacturing
Tube ends are rolled instead of threaded to minimize downtime, and thread leaking/failure

For Recirculating Booms
Compatible boom fittings & tubing for building recirculating booms

1" Stainless Steel Tubing
Shares 1" sch40 pipe outside diameter (1.315" OD.) with larger 1.25" inside diameter

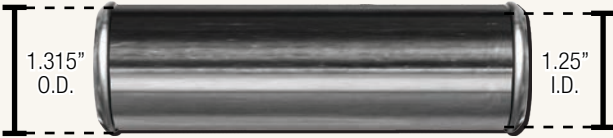

Lighter 1" Boom = Less Fuel
weighs 66% of aluminum
weighs 23% of sch40 pipe
Lighter than hose

1/2" Stainless Steel Tubing
Shares 1/2" sch40 pipe outside diameter (0.84" OD.) with larger 0.788" inside diameter



Lighter 1/2" Boom = Less Fuel
weighs 80% of aluminum
weighs 28% of sch40 pipe
Lighter than hose

Sprayer Tube Shipping Consideration - Length

Depending on firm requirement for sprayer tube length, shipping costs are less expensive for tubes that are less than 11' (132") in length.

Pre-punched Outlet Spacing

Sprayer tubes are commonly pre-punched to 20" nozzle spacing, but also available in pre-punched to 10", 15", 30" or custom spacing as required.

Picking the Correct Style of Tube End & Length

With many different sprayer boom designs, it is important to identify key differences that will determine what length and configuration of boom tube that is required.

Simplify the process by starting from the narrowest tube possible, with additional length included onto the ends as required for configuration or fittings.

The below examples are styles of 'ends' of tubes that are commonly needed. Outlet spacing for the examples is 20", but the same concept applies for any outlet spacing.

Standard Tube Ends (2")

Tubes that have 2" of tube after the last nozzle body are commonly used with QN100 or QF100 plumbing parts.

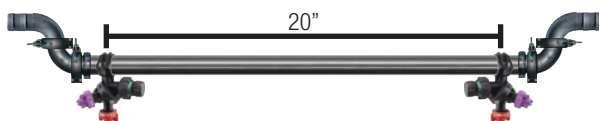

COMBO-RATE Boom End Flush Valve Ends (18")

The CR BEFV replaces the last nozzle body, and from the end of tube, requires 2" to the nozzle body center, so an 18" end length is required.



Remember the number of outlet holes on the tube would be 1 less for each Combo-Rate boom end flush valve used.

Center-fed Section Ends (8" or 8.25")

Tubes that are center-fed with Tees require a pair of longer tube sides to maintain proper 20" spacing with a 4" (QN100) or 3.5" (QF100) wide tee.

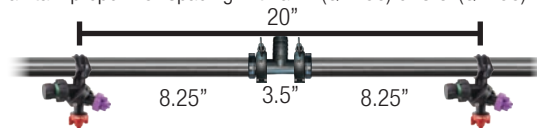

10" Ends for Tube to Tube SST

For situations that require two smaller tubes to be joined tube to tube, the 10" ends maintain 20" spacing between the last nozzle bodies

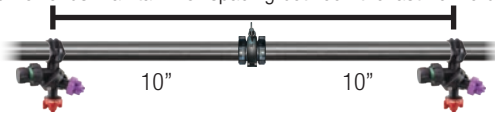

NEW Quick-Flange (QF100) Fittings

A series of flanged adapters that convert either a rolled-end tube (like SST) or other 1.315" OD tube/pipe to a common 1" flange and tool-free clamp system.

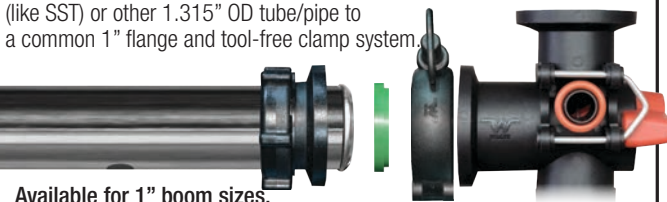

Available for 1" boom sizes.

Quick Nut (QN100 & QN50) Fittings

A series of quick couplers that use the rolled end to connect to a variety of sweep sprayer fittings to maximize flow capacity and boom hygiene.



Available in both 1" & 1/2" boom sizes.

Quick-Flange Fittings & Fluid Supply System

The Quick-Flange Advantage



Perfect Recirc. Booms



Robust & Positive Seals



Stronger Compact Fittings



No Threads or Sealant Required



Remove Deadspots for Boom Hygiene

Retrofitting & Flange Compatibility

Fittings available for complementing any sort of sprayer boom & more.

CAN BE OUTFITTED FOR:

1" sch40 Pipe (1.315" OD)

Any 1" Flanged Fittings

Wilger Stainless Tubing

Case Thin Wall Stainless

Compatible with other 1" Flange Fittings

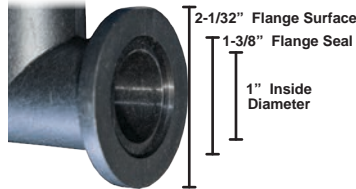

Compact & Robust Sweep Fittings

Sweep fittings reduce turbulence & pressure loss, producing a sprayer that is capable of higher flow rates with less restriction.

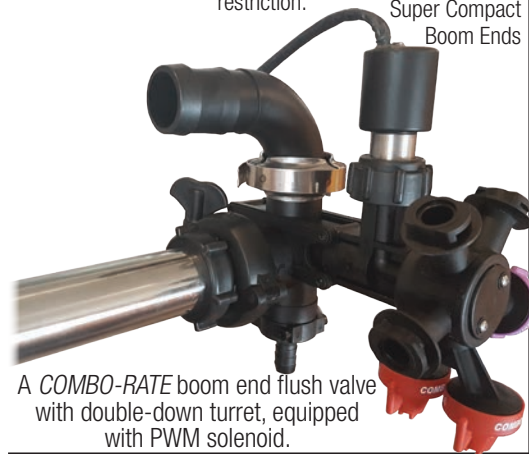

A COMBO-RATE boom end flush valve with double-down turret, equipped with PWM solenoid.

Recirculation Made Easy

Many options for any recirculating boom

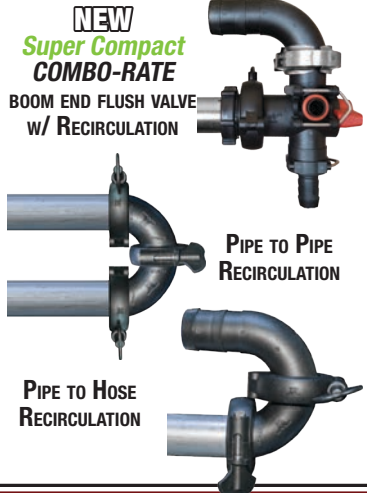

Building a SST Sprayer Boom for Quick-Flange (QF100)

When planning to build a sprayer boom with Wilger's Stainless Steel Tube, follow these steps to break down the process and engineer the best performing sprayer boom possible.

STEP 1 Determine tube lengths & spacing required for each section. Simply count the number of outlets on each required boom tube between each fold, accounting for separated sections (if required).

STEP 2 Split up nozzle sections based on boom type, or to minimize boom tube length (e.g. 11 nozzles max).

For Recirculating (R) Sprayer Booms: Anticipate keeping sections made with as few boom tubes as possible, as plumbing fittings will only be on the either end of the tube (aside from any tube-to-tube joints on the same section)

For Standard (S) Sprayer Booms: Anticipate splitting sections in half, allowing for a center-fed sweep tee, providing optimal pressure to each nozzle in the section.

STEP 3 Determine whether any boom end nozzle bodies (like Combo-Rate Boom End Flush Valve nozzle body) are being used, as they may require different lengths (as they encompass the last outlet on a sprayer boom)

STEP 4 Determine the tube end spacing depending on the fittings used.
CR BEFV requires 18" tube end. Tube Joint requires 10" tube end. Regular fittings requires 2" end.

For example, a 5-section recirculation sprayer, with 72 outlets (on 20" spacing) using Combo-Rate End Flush Valve Bodies

	SECTION 1	SECTION 2		SECTION 3	SECTION 4		SECTION 5
STEP 1 Section sizing	11 nozzles	20 nozzles		10 nozzles	20 nozzles		11 nozzles
STEP 2 Tube Lengths	11 outlet	10 outlet + 10 outlet joined		10 outlet	10 outlet + 10 outlet joined		11 outlet
STEP 3 Specialty Boom End Considerations	11 outlet -2 (CR BEFV) 9 outlet tube	10 outlet -1 (CR BEFV) 9 outlet tube	10 outlet -1 (CR BEFV) 9 outlet tube + joint	10 outlet -2 (CR BEFV) 8 outlet tube	10 outlet -1 (CR BEFV) 9 outlet tube + joint	10 outlet -1 (CR BEFV) 9 outlet tube + joint	11 outlet -2 (CR BEFV) 9 outlet tube
STEP 4 Tube/End Lengths to Order	9 outlet tube with 18" End (CR BEFV) & 18" End (CR BEFV)	9 outlet tube with 18" End (CR BEFV) & 10" End (joint)	9 outlet tube with 10" End (joint) & 18" End (CR BEFV)	8 outlet tube with 18" End (CR BEFV) & 18" End (CR BEFV)	9 outlet tube with 18" End (CR BEFV) & 10" End (joint)	9 outlet tube with 10" End (joint) & 18" End (CR BEFV)	9 outlet tube with 18" End (CR BEFV) & 18" End (CR BEFV)

Quick-Flange Fittings & Tubing for Sprayers

NEW Product Release: Quick Flange Boom Fittings & Accessories

A new product line of engineered sprayer boom fittings to outfit the next generation of sprayers is now here! With emphasis on cutting out contamination, integrating recirculation functions, and generally improving the ability to build a better boom. Wilger is committed to developing and producing high quality liquid application components that are used in setting best practices in an ever-changing environment.

Adapting Quick-Flange Fittings to 1" PIPE, 1" QN SST, or Case TWS Booms

QF100 Fittings can be seamlessly retrofitted or adapted to any 1" Pipe, QN SST, or TWS Booms to a 1" Flange Fitting.

Case TWS to Quick-Flange

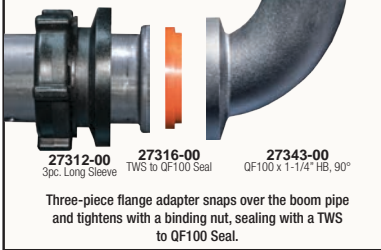

1" SST to Quick-Flange

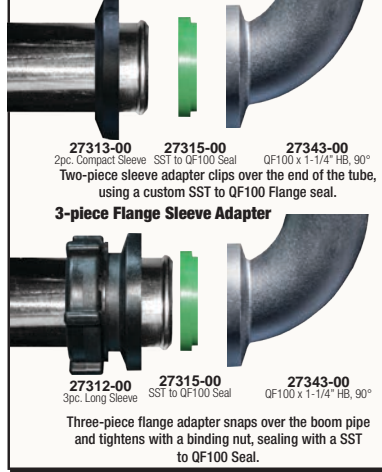

NEW Cut Pipe to Quick-Flange

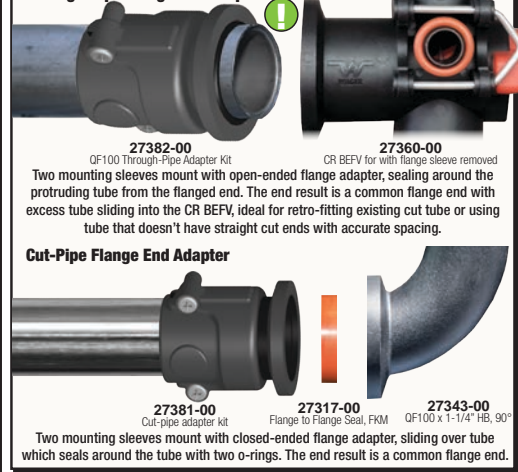

QF100 fittings for a Traditional Sprayer Boom

Conventionally plumbed Center-Fed Section using Case Thin-Walled Stainless (TWS) Boom Tube, with last nozzle body integrated directly into the flush valve

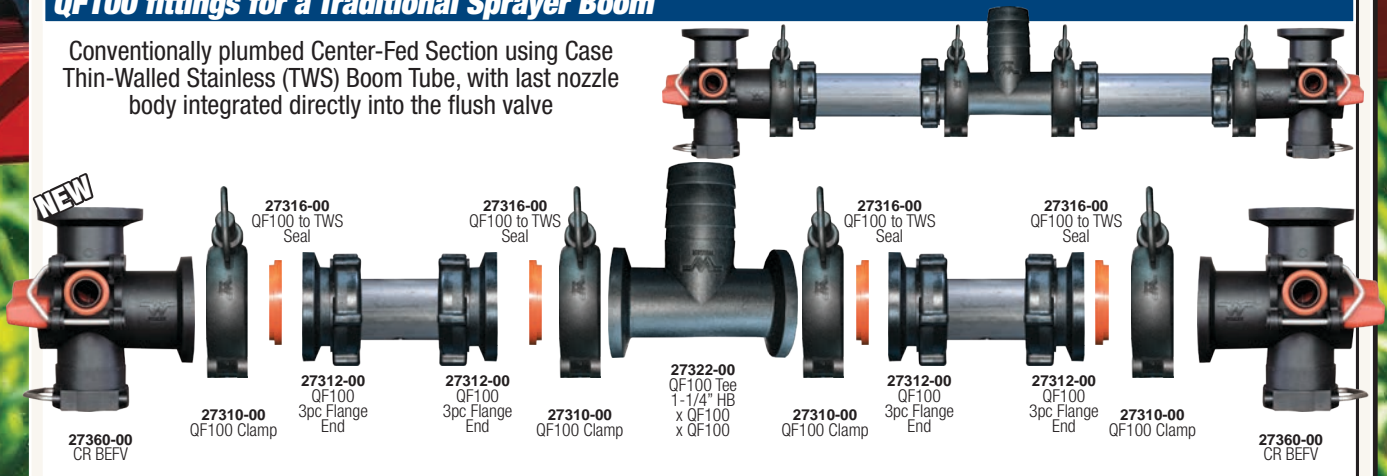

QF100 fittings for a Recirculating Sprayer Boom

Recirculating sprayer boom plumbed using Wilger Stainless Steel Tube (SST), with last nozzle body integrated directly into the flush valve and recirc hose barbs.

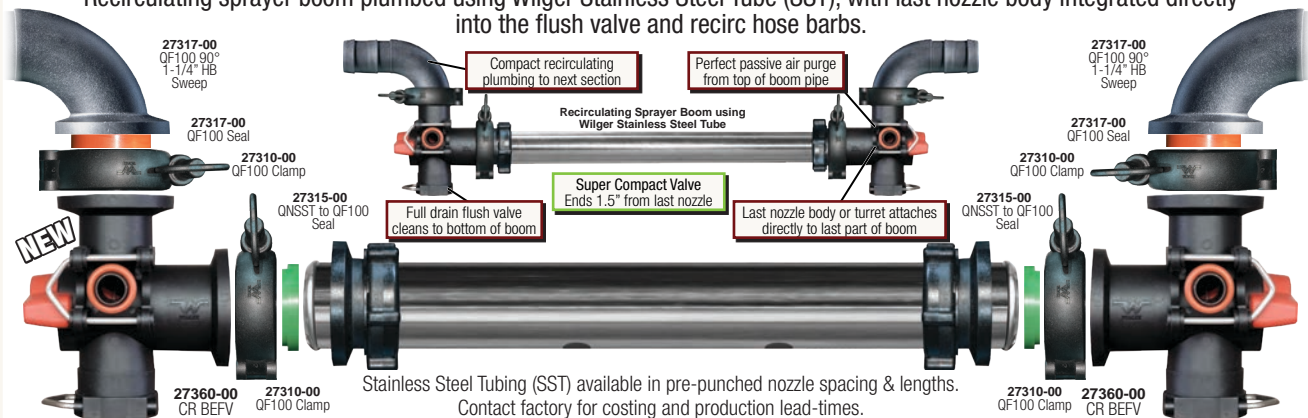

Quick-Flange Fittings & Fluid Supply System

Quick-Flange Clamps

Compact & robust clamps for easy installation & adjustment with hinging bolt. Compatible with common 1" flange fittings.

Poly Clamp	Part#
Butterfly Nut & Bolt	27310-00
Castle Nut & Bolt	27311-00

Glass-reinforced Polypropylene Clamp & Stainless Steel Hardware



QF100 Elbows & Hose Barb Fittings

Compact & high flow sweep fittings for less pressure loss & higher flow capability for a better performing sprayer boom.



Size/Style	Description	Part#
Flange	Elbow, 90°, Compact	27324-00
x Flange	Elbow, 45°, Compact	27326-00
1"	QF100 x 1" HB, Straight	27331-00
Hose Barb x QF100	QF100 x 1" HB, 45° Sweep	27332-00
	QF100 x 1" HB, 90° Sweep	27333-00
1-1/4"	QF100 x 1-1/4" HB, Straight	27341-00
Hose Barb x QF100	QF100 x 1-1/4" HB, 45° Sweep	27342-00
	QF100 x 1-1/4" HB, 90° Sweep	27343-00

QF100 Adapters & Cover Caps

Auxiliary fittings and caps for adapting Quick-Flange fittings to other threaded boom fittings & existing plumbing.



Size/Style	Description	Part#
Threaded Adapter	QF100 x QN100 Male Thread	27351-00
	QF100 x TWS Male Thread	27352-00
Plug Cap	QF100 Plug Cap	27353-00

Example: Adapting to Threaded Boom End Flush Valves

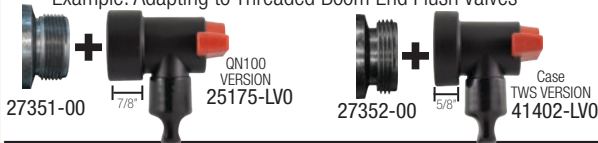

Tube & Pipe End Adapter Seals & Kits

Adapters & seals to convert different styles of tube & pipe to a common flanged end.

Boom End Type	Adapter Kit
Wilger SST rolled end OR Case TWS flared end	[3pc] 27312-00 [2pc] 27313-00
Cut pipe end	27381-00
Through pipe end	27382-00

Flange End Seals



27315-00	27316-00	27317-00
Tube to Flange Seals		
SST Tube x Flange	27315-00	
TWS Tube x Flange	27316-00	
Flange x Flange	27317-00	

Tube to Tube Seals

For tube end to tube end joints

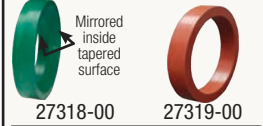

27318-00	27319-00
Tube to Tube Seals	
Wilger SST to SST	27318-00
Case TWS to TWS	27319-00

3pc End Adapter

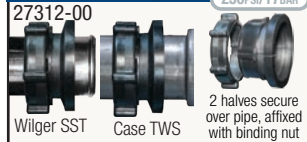

Max Pressure 250psi/17BAR

2 halves secure over pipe, affixed with binding nut

Wilger SST uses flared taper gasket
27315-00

2pc End Adapter



Max Pressure 150psi/10BAR

2 halves secure over SST

Case TWS uses stepped gasket
27316-00

Cut Pipe End Adapter Kit



27381-00 For any 1.315" OD pipe/tube
Drill two 3/8" holes, 1" front pipe end

Uses QF100 Standard Gasket
27317-00

Through Pipe Adapter Kit



27382-00 For any 1.315" OD pipe/tube
Drill two 3/8" holes, 2-3" from end

Use with CR BEFV only

NEW COMBO-RATE Boom End Flush Valve (CR BEFV)

The Better Boom End Nozzle Body & Valve

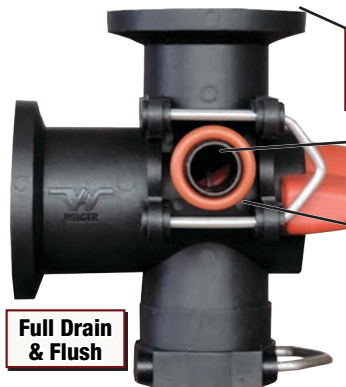

Saves Space

<2" from last nozzle body

Perfect for Recirculating Booms
Recirc fittings attach directly above last nozzle to fit in any boom frame

Passive Air Purge
Nozzle pulls air directly from the top of boom pipe reducing nozzle run-on

Use with COMBO-RATE turrets
Compatible with all COMBO-RATE stacking nozzle bodies and turrets

Full Drain & Flush

No Threads or Sealants
No potential for leaking threads

Compatible with any 1" Flange Parts

Full retrofit-ability and future-proofing

Valve version	Part#
Recirc Model w/ plugs	27361-00
Non-Recirc model w/ plugs	27362-00
Non-recirc w/ butterfly nut	27362-WN

QF100 Tee Fittings

Sweep Tees

Compact sweep tees for less pressure loss & higher flow capability for a better performing sprayer boom.

Sweep Tee Fittings	Part#
QF100 x QF100 x QF100	27371-00
QF100 x QF100 x 1-1/4" HB	27372-00
QF100 x QF100 x 1" HB	27373-00



Regular Tees

Compact tees for flat bottom drainage.

Sweep Tee Fittings	Part#
QF100 x QF100 x QF100	27321-00
QF100 x QF100 x 1-1/4" HB	27322-00
QF100 x QF100 x 1" HB	27323-00

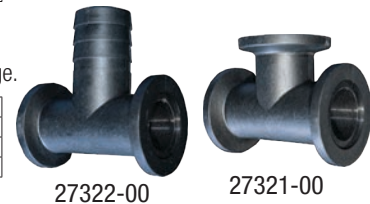

1" Quick-Nut (QN100) Boom Fittings & Stainless Steel Tube

The Quick-Nut Fitting & SST Advantage

Lighter Booms - Wilger SST
weighs 66% of aluminum
weighs 23% of sch40 pipe
Lighter than hose

Lower Cost
compared to other pipe plumbed
sprayer booms

Recirculating Booms
Compatible boom fittings & tubing
for building recirculating booms

Less Chemical Residue
compared to hose-plumbed sprayers

High Flow Boom Pipe
Maintains 1" pipe outside diameter,
but inside diameter flows like 1-1/4"

Sweep Fittings
reduce turbulence
& increase boom flow capacity

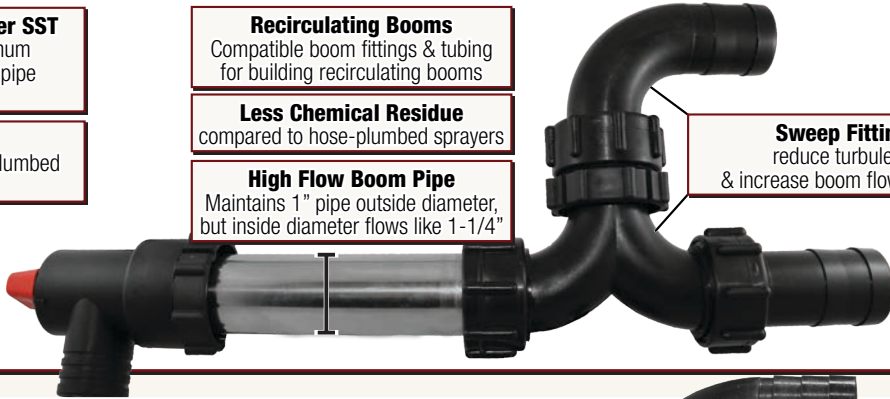

QN100 Fittings for a Conventional Sprayer Boom

Contact Wilger for Custom Boom Tube & Hole Configurations for your sprayer boom.

[CANADA] Wilger Industries Ltd.
1 (833) 242-4121
info@wilger.net

[USA] Wilger Inc.
1 (877) 968-7695
WilgerESC@WilgerESC.com

Example of a few possible configurations of
1" Quick-Nut (QN100) Sprayer Fittings

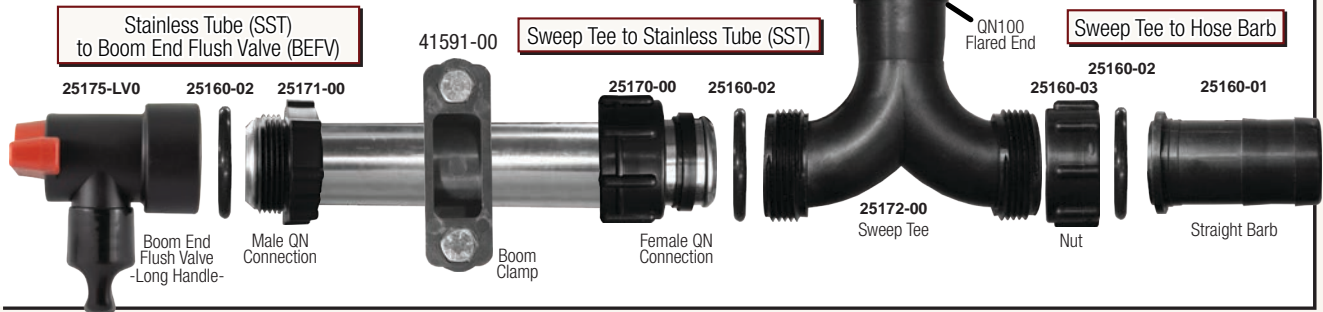

QN100 Connectors & Components

Easy to use boom end fittings and connectors to adapt 1" Wilger Stainless Steel Tubing (SST) to QN100 fittings.

Component	Description	Part#
SS Tube End Adapters	Female Thread End, 2pc	25170-00
Quick Nut	Male Thread End, split ring	25171-00
Plug	Nut with QN100-F Thread	25160-03
O-ring for QN100 Connections	QN100 x Plug Cap	25163-01
Threaded Adapters	#219 O-ring, FKM	25160-02
Boom Tube Clamps	#219 O-ring, viton	25160-v2
Replacement Parts	QN100 x 3/4" NPT-F Thread	25164-01
	1" NPT-F x QN100M Bushing	25137-00
	Half Clamp, for 1" SST (1.31" OD)	41591-00
	Half Clamp, for 1-1/4" Tube	41590-00
	BEFV Cover Cap	25175-10
	BEFV Seal Repair Kit (2 valves)	25175-11
	BEFV Handle, Long	25175-13
	BEFV Handle, Short	25175-03

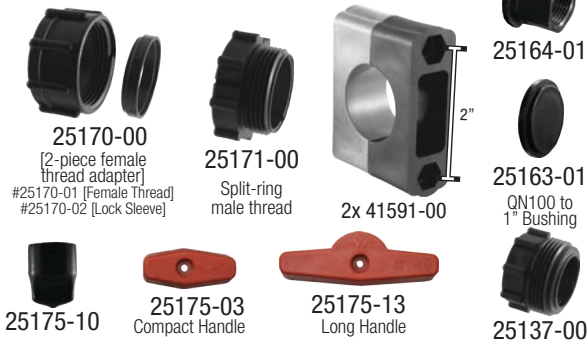

QN100 Tee Fittings

Compact & lightweight sweep tees for any sprayer boom configuration.

Description	Part#
QN100 Flare x QN100M x QN100M	27311-00
1" Hose x QN100M x QN100M	27311-00
1-1/4" Hose x QN100M x QN100M	27311-00



QN100 Hose Barb Fittings

Compact & lightweight hose barb fittings for any sprayer boom configuration.

Size/Style	Description	Part#
1" HB x QN100	QN100 x 1" HB, Straight	25166-01
	QN100 x 1" HB, 90° Sweep	25167-01
1-1/4"	QN100 x 1-1/4" HB, Straight	25160-01
Hose Barb x QN100	QN100 x 1-1/4" HB, 45° Sweep	25162-01
	QN100 x 1-1/4" HB, 90° Sweep	25161-01



QN100 & 1" NPT Boom End Flush Valves

Compact valve for full-drain flushing of booms.

Type	Description	Part#
QN100	QN100 BEFV, Short Handle	25175-V0
	QN100 BEFV, Long Handle	25175-LV0
1" NPT-F	1" NPT BEFV, Short Handle	25176-V0
	1" NPT BEFV, Long Handle	25176-LV0



1/2" Quick-Nut (QN50) Boom Fittings & Stainless Steel Tube

QN50 Fittings for a Conventional Sprayer Boom

Contact Wilger for Custom Boom Tube & Hole Configurations for your sprayer boom.

[CANADA] Wilger Industries Ltd.
1 (833) 242-4121
info@wilger.net

[USA] Wilger Inc.
1 (877) 968-7695
WilgerESC@WilgerESC.com

Example of a few possible configurations of 1/2" Quick-Nut (QN50) Sprayer Fittings

Stainless Tube (SST) to Plug Cap

Sweep Tee to Stainless Tube (SST)

Sweep Tee to Hose Barb

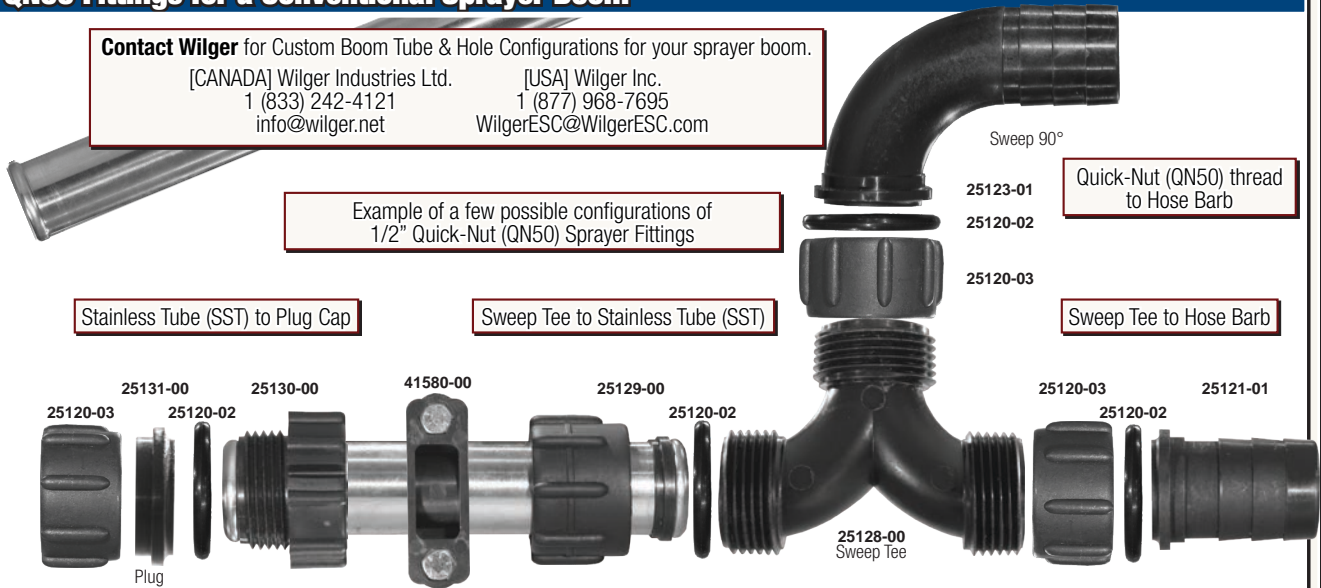

QN50 Connectors & Components

Easy to use boom end fittings and connectors to adapt 1/2" Wilger Stainless Steel Tubing (SST) to QN50 fittings.

Component	Description	Part#
SS Tube End Adapters	Female Thread End, 2pc	25129-00
Quick Nut	Male Thread End, split ring	25130-00
Plug	Nut with QN50-F thread	25120-03
O-ring for QN50 Connections	QN50 x Plug Cap	25131-01
Thread Adapters	#116 O-ring, FKM	25120-02
Boom Clamp	#116 O-ring, viton	25120-V2
	QN100 x 1/4" NPT-F Thread	25127-01
	Half Clamp, 1/2" SST (0.84" OD)	41580-00

For QN50 Connections



25120-02



25131-01



25130-00

25129-00
2-piece kit: #25129-01 [Nut]
#25129-02 [Sleeve]

41580-00

25120-03

QN50 Tee & Hose Barb Fittings

Compact & lightweight tee & hose barb fittings for any sprayer boom configuration.

Size/Style	Description	Part#
TEE	QN50M x QN50M x QN50M	25128-00
1/2" Hose Barb x QN50	QN50 x 1/2" HB, Straight	25120-01
	QN50 x 1/2" HB, 45° Sweep	25124-01
	QN50 x 1/2" HB, 90° Sweep	25122-01
3/4" Hose Barb x QN50	QN50 x 3/4" HB, Straight	25121-01
	QN50 x 3/4" HB, 45° Sweep	25125-01
	QN50 x 3/4" HB, 90° Sweep	25123-01

QN50-M Thread
3/4" NPT
Compatible



25128-00



25123-01

25122-01

25121-01

25120-01

Case Thin Wall Stainless (TWS) Tube Fittings

Easy to use boom end fittings and connectors to adapt to 1" Case Thin walled stainless steel sprayer booms.

Component	Description	Part#
TWS Male Tube End Adapter (3pc)	Male End Adapter, Left Thread	41400-04
	Male End Adapter, Right Thread	41400-05
	Male End Adapter, Binding Nut	41400-02
Coupler	TWS-F to QN100-F Coupler	41400-01
Quick Nut	TWS Nut, use with QN100 HB	41400-03
O-ring for TWS Connections	#209 square O-ring, FKM	25160-04
	#209 square O-ring, viton	25160-v4
	1" NPT-F x TWS-M Bushing	41403-00
Threaded Adapters	1" NPT-F x TWS-M Bushing kit w/ o-ring	41403-v0
	Half Clamp, for 1" TWS (1.31" OD)	41591-00
Boom Clamp	Flush Valve, Short Handle	41402-V0
	Flush Valve, Long Handle	41402-LV0
	BEFV Seal Repair Kit (2 valves)	25175-11
	BEFV Cover Cap	25175-10
Boom End Flush Valves (BEFV) & Replacement Parts	BEFV Handle, Long	25175-13
	BEFV Handle, Short	25175-03
	3-piece Adapter TWS Male Thread	#41400-04 [Left] #41400-05 [Right] #41400-02 [Binding Nut]

41400-03



25160-04



41403-00



25175-10



25175-13
Long Handle

25175-03
Compact Handle

TWS Flush Valves

Compact & Robust Full Drain Flush Valve



Case TWS BEFV
41402-LV0

Adapting a TWS Flush Valve to 1" NPT-M End

A bushing kit can adapt to any 1" NPT-M pipe end

41403-v0 BUSHING KIT 41402-V0



Hose Barb Fittings for TWS

TWS Connectors are compatible with QN100 Hose Barb Fittings & Accessories

Size/Style	Description	Part#
Plug	QN100 x Plug Cap	25163-01
Adapters	QN100 x 3/4" NPT-F Thread	25164-01
1" HB x QN100	QN100 x 1" HB, Straight	25166-01
	QN100 x 1" HB, 90° Sweep	25167-01
1-1/4"	QN100 x 1-1/4" HB, Straight	25160-01
Hose Barb x QN100	QN100 x 1-1/4" HB, 45° Sweep	25162-01
	QN100 x 1-1/4" HB, 90° Sweep	25161-01



41400-00

25160-01

41400-03

25160-04

TWS to QN100 Coupler



TWS Female Thread

QN100 Female Thread

41401-01

Couples TWS-M and QN100M ends

O-ring Seal (ORS) Fittings & Components

The O-ring Seal (ORS) Fitting Advantage



Superior Chemical Resistance



Fittings Swivel 360°



Stronger Compact Fittings



No Threads or Sealant Required

Hose Barb Inlet

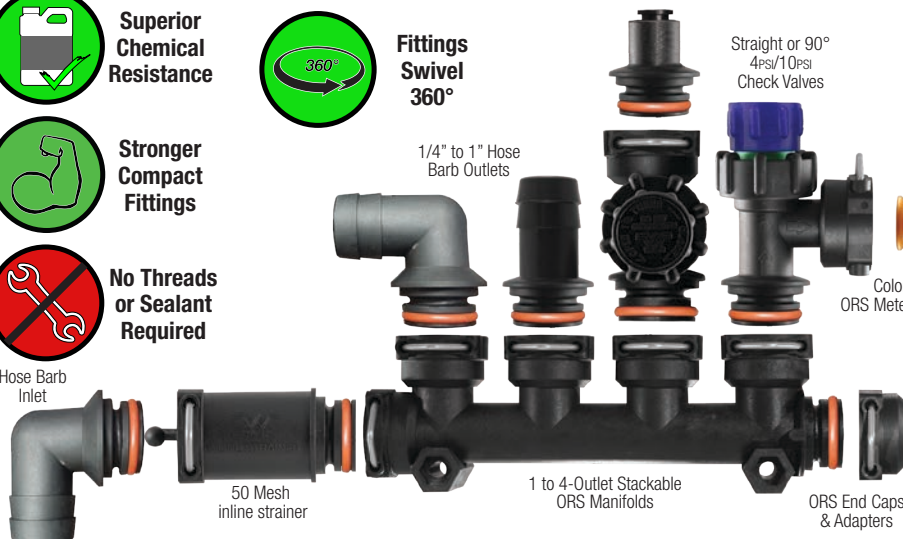

50 Mesh inline strainer

1 to 4-Outlet Stackable ORS Manifolds

ORS End Caps & Adapters

Straight or 90°
4psi/10psi
Check Valves

1/4" to 1" Hose Barb Outlets

Color-coded ORS Metering Orifices



Full Line of Metering Orifices
Precision metering orifices for rates as low as 1.8 us gal/acre

1/8" to 3/8" Push-In Tube Quick Connect Outlets

Standard FKM O-ring Seals
FKM o-rings are used to maximize chemical resistance & durability.

Compatible with Flow Indicators
Wilger ORS fittings are used for both Flow Indicator & EFM systems

ORS to ORS Check Valves

Diaphragm check valves with an ORS-F outlet for in-line outlet control to minimize dripping



Check Valve Style	90° Outlet	Straight
Dia. Check Valve	20550-00	20555-00
[10psi] Manual On/Off	20551-00	20556-00
[4psi] Manual On/Off	20551-P4	20556-P4
Air-Off Operated	20552-00	20557-00
For PWM/no-check	20553-00	20558-00

*4PSI check valves available: change "-00" to "-P4". For ultra-low flow (<0.01 us gpm), 4PSI may be required.

10 PSI Manual ON/OFF Check Valve, Straight
20556-00



Manual ON/OFF Valves



When the knob is **OPEN**, it acts as a standard 10 PSI check valve.
When the knob is **CLOSED**, it turns off flow to that outlet **ONLY**. It does not turn off flow to any other outlets.

ORS to COMBO-JET Check Valves

Diaphragm check valves with a Combo-Jet outlet for spray tip or cap metering or spraying.



Check Valve Style	90° Outlet
Dia. Check Valve	20560-00
[10psi] Manual On/Off	20561-00
[4psi] Manual On/Off	20561-P4
Air-Off Operated	20562-00
PWM/no-check	20563-00

COMBO-JET Caps & Metering Orifices

A variety of radialock or COMBO-JET caps & metering orifices are available for hose barb, push-in-tube, spray tips, and other adapters.



ORS Hose Barb Inlets/Outlets

O-ring seal hose barb inlets and outlets that connect to hose on the inside diameter. Compatible with all ORS metering orifices for metering flow.

Hose Barbs	Orientation	Part#
1/4"	Straight	20500-00
	Straight	20501-00
3/8"	90°	20511-00
	Straight	20502-00
1/2"	90°	20512-00
	Straight	20503-00
5/8"	90°	20513-00
	Straight	20504-00
3/4"	90°	20514-00
	Straight	20505-00
1"	90°	20515-00
	Straight	20506-00



ORS Push-in-Tube Outlets

O-ring seal quick-connect outlets that seal around the outside diameter of a tube. Compatible with all ORS metering orifices for metering flow.

Tube O.D.	Orientation	Part#
1/4"	Straight	20506-00
	90°	20516-00
5/16"	Straight	20508-00
	90°	20528-00
3/8"	Straight	20507-00
	90°	20517-00

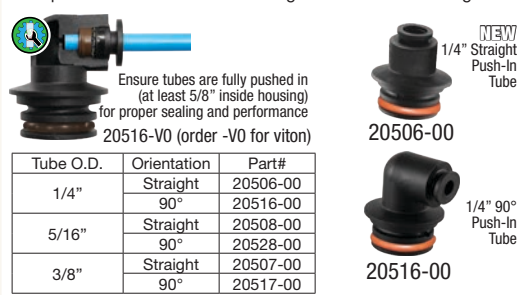

ORS End Caps & Adapters

O-ring seal end caps are used on any ORS male ports, commonly used on flow indicators, manifolds, or even other outlets to make coupler assemblies.

Style & Size	Part#	
End Cap	20521-00	
Push-in Tube (seals on O.D.)	1/4"	20540-00
	5/16"	20541-00
	3/8"	20542-00
NPT-F Thread	1/4"	20535-00
	3/8"	20536-00
	1/2"	20537-00
NPT-M Thread	1/4"	20530-00

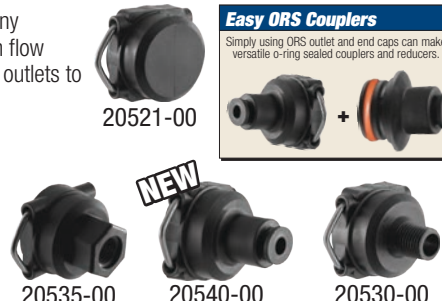

Easy ORS Couplers

Simply using ORS outlet and end caps can make versatile o-ring sealed couplers and reducers.



ORS Outlet Adapters & Plugs

O-ring seal outlets with female threads, plugs and more. Compatible with all ORS metering orifices for metering flow.

Type	Orientation	Part#
1/4" NPT-F	Straight	20519-00
	90°	20518-00
ORS x Sq Lug	Straight	20549-00
ORS Plug	Straight	20529-00



ORS x Square Lug adapter adapts to any square lug nozzle cap (e.g. Teejet/Hypro/Varitarget)

O-ring Seal (ORS) Manifolds & Tees

PRO TIP: Lubricate ORS fittings before assembly

When assembling any flow indicator or O-ring seal (ORS) parts, using a touch of lubricant (e.g. liquid silicone) on the O-ring makes assembly easy.

NEW ORS Inline Strainer

Inline strainer with removable 50-mesh cartridge can be reversed for universal flow direction.

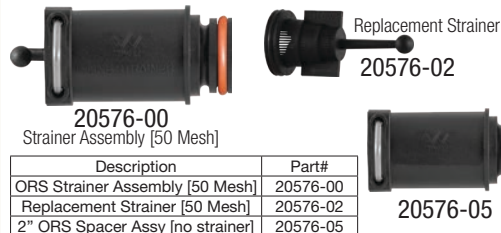

Description	Part#
ORS Strainer Assembly [50 Mesh]	20576-00
Replacement Strainer [50 Mesh]	20576-02
2" ORS Spacer Assy [no strainer]	20576-05

ORS Tees & Other Fittings

A variety of fittings for splitting manifolds, ORS-F outlets or other auxiliary functions.



Description	Part#
90° ORS Elbow [M x F]	20520-00
ORS Tee w/ 1/4" NPT-F [M x M x F w/ 1/4" NPT-F]	20526-00
3/8" x Blind ORS Tee [Blind F x M x 3/8" NPT-F]	20523-00
3/8" NPT-F x ORS Tee [F x M x 1/8" NPT-F]	20524-00
2-Outlet ORS-F Splitter [F x F x M]	20527-00
1" NPT-F x ORS Tee [M x M x 1" NPT]	20525-00

O-ring Seal (ORS) Manifolds

ORS manifolds can be configured and plumbed to any size, shape or configuration to suit any application equipment needs such as liquid fertilizer manifolds, estate sprayer manifolds, or any other liquid manifold plumbing.



Model	O-ring	Part#
1-Outlet Manifold	FKM	20571-00
	Body only	20571-01
2-Outlet Manifold	FKM	20572-00
	Body only	20572-01
3-Outlet Manifold	FKM	20573-00
	Body only	20573-01
4-Outlet Manifold	FKM	20574-00
	Body only	20574-01

Example ORS Manifold Configurations

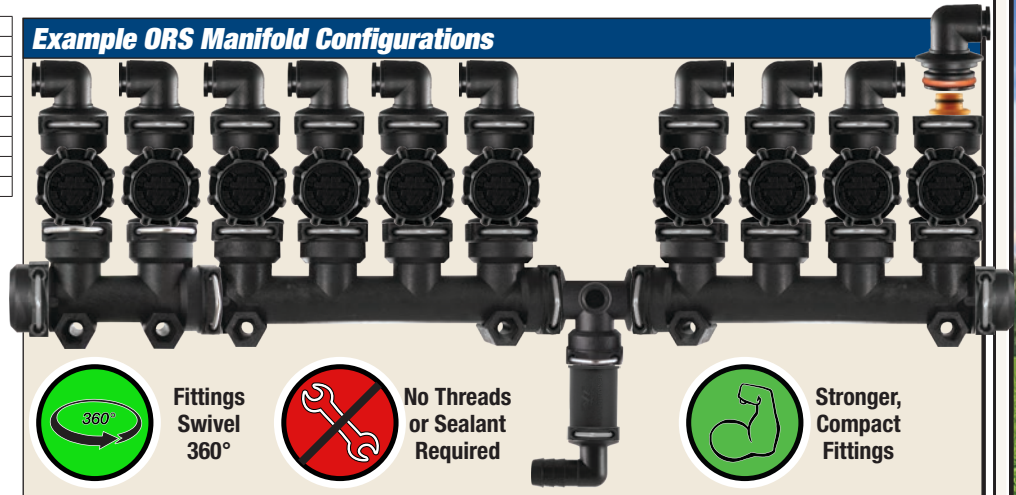

Fittings Swivel 360°



No Threads or Sealant Required



Stronger, Compact Fittings

O-ring Seal (ORS) Metering Orifices

Precision metering orifices for metering liquid fertilizer or chemical made of chemically resistant and rustproof material. The easier to handle orifices seal positively into any O-ring seal (ORS-M) fitting port, and cannot be inserted backwards ensuring proper fit and seal.

Available in precision molded color-coded sizes (more consistent) or custom drilled sized orifices (black).

Color-Coded Molded Orifices



21500-V01

Custom Drilled Orifices (replace XXX with hole size)



21XXX-00

Blank Plug (no holes)



21000-00



Color-coded size makes identifying orifices easy

Metering Orifice type, seal & ORS Orifice Part#	Custom Drilled ORS Orifices		Color Coded Molded ORS Orifices		Blank Orifice or Plug	
	FKM O-ring	VITON O-ring	003 to 007 size	01 to 20 size	FKM O-ring	VITON O-ring
21XXX-00	21XXX-V0	21500-VXXX	21500-VXXX	21500-VXXX	21000-00	21000-V0
Color	Black	Black	Color Coded	Color Coded	Black	Black

Download Tip Wizard Today!



Download on the App Store

GET IT ON Google Play

TIP WIZARD

Use the FREE Tip Wizard app to select your metering orifice. Simply input rate, speed & spacing, and get the best orifice for the job. Available at www.WILGER.NET

O-ring Seal (ORS) Metering Orifice Charts

Tip Wizard makes metering orifice selection easy!

ORS metering orifices have a sized hole that determines the flow rate. Flow rate is determined based on the pressure and density of the liquid being applied. To determine a required flow rate, you must first know the required application rate, speed and spacing.

Available on



Calculating Required Flow Rate for Metering Orifice Selection

To determine the flow rate (or application rate), use the following equations & density conversion chart:

$W = \text{Outlet Spacing (INCH)}$
 $\text{conv} = \text{Conversion Factor based on specific gravity/weight of liquid}$
 $\text{GPM (per outlet)} = \frac{\text{GPA} \times \text{mph} \times W \times \text{conv}}{5940}$
 $\text{GPA} = \frac{5940 \times \text{GPM (per outlet)}}{\text{mph} \times W}$

EASY-TO-USE ORS orifice and ball selector calculator available @ www.WILGER.NET

Solution Weight (lb/ us gallon)	Specific Gravity	Conversion Factor (conv)
8.34 (Water)	1.00	1.00
10.65 (28-0-0)	1.28	1.13
11.65 (10-34-0)	1.39	1.18

Orifice Part#*	Flow Rate (US gallons/minute)							Orifice Part#*	Flow Rate (US gallons/minute)						
	10PSI	15PSI	20PSI	25PSI	30PSI	35PSI	40PSI		10PSI	15PSI	20PSI	25PSI	30PSI	35PSI	40PSI
21009-XX	0.005	0.006	0.007	0.008	0.009	0.010	0.010	21075-XX	0.346	0.424	0.490	0.548	0.600	0.648	0.693
21011-XX	0.008	0.010	0.011	0.013	0.014	0.015	0.016	21078-XX	0.387	0.474	0.547	0.612	0.670	0.724	0.774
21013-XX	0.011	0.013	0.016	0.017	0.019	0.021	0.022	21500-V03	0.393	0.433	0.563	0.630	0.690	0.745	0.797
21015-XX	0.014	0.018	0.020	0.023	0.025	0.027	0.029	21081-XX	0.410	0.502	0.580	0.648	0.710	0.767	0.820
21500-V003	0.015	0.018	0.021	0.024	0.026	0.028	0.030	21083-XX	0.450	0.552	0.637	0.712	0.780	0.842	0.901
21018-XX	0.021	0.025	0.029	0.033	0.036	0.039	0.042	21086-XX	0.468	0.573	0.661	0.739	0.810	0.875	0.935
21500-V005	0.025	0.030	0.035	0.039	0.043	0.046	0.050	21089-XX	0.491	0.601	0.694	0.776	0.850	0.918	0.981
21020-XX	0.026	0.032	0.037	0.041	0.045	0.049	0.052	21500-V10	0.502	0.615	0.710	0.794	0.870	0.940	1.00
21022-XX	0.031	0.037	0.043	0.048	0.053	0.057	0.061	21091-XX	0.525	0.643	0.743	0.831	0.910	0.983	1.05
21500-V007	0.033	0.041	0.047	0.053	0.058	0.063	0.067	21093-XX	0.548	0.672	0.776	0.867	0.950	1.03	1.10
21025-XX	0.039	0.048	0.056	0.062	0.068	0.073	0.079	21096-XX	0.589	0.721	0.833	0.931	1.02	1.10	1.18
21026-XX	0.043	0.053	0.061	0.068	0.075	0.081	0.087	21500-V125	0.624	0.764	0.882	0.986	1.08	1.17	1.25
21027-XX	0.046	0.056	0.065	0.072	0.079	0.085	0.091	21102-XX	0.652	0.799	0.923	1.03	1.13	1.22	1.30
21028-XX	0.049	0.060	0.069	0.078	0.085	0.092	0.098	21104-XX	0.675	0.827	0.955	1.07	1.17	1.26	1.35
21500-V01	0.050	0.062	0.071	0.079	0.087	0.094	0.100	21107-XX	0.733	0.898	1.037	1.16	1.27	1.37	1.47
21029-XX	0.064	0.078	0.090	0.100	0.110	0.119	0.127	21500-V15	0.751	0.919	1.061	1.19	1.30	1.40	1.50
21031-XX	0.064	0.078	0.090	0.100	0.110	0.119	0.127	21110-XX	0.774	0.948	1.094	1.22	1.34	1.45	1.55
21500-V015	0.075	0.092	0.106	0.119	0.130	0.140	0.150	21113-XX	0.820	1.00	1.16	1.30	1.42	1.53	1.64
21035-XX	0.081	0.099	0.114	0.128	0.140	0.151	0.162	21116-XX	0.860	1.05	1.22	1.36	1.49	1.61	1.72
21037-XX	0.087	0.106	0.122	0.137	0.150	0.162	0.173	21120-XX	0.889	1.09	1.26	1.41	1.54	1.66	1.78
21039-XX	0.098	0.120	0.139	0.155	0.170	0.184	0.196	21125-XX	0.981	1.20	1.39	1.55	1.70	1.84	1.96
21500-V02	0.104	0.127	0.147	0.164	0.180	0.194	0.208	21500-V20	0.999	1.22	1.41	1.58	1.73	1.87	2.00
21041-XX	0.110	0.134	0.155	0.173	0.190	0.205	0.219	21128-XX	1.02	1.25	1.45	1.62	1.77	1.91	2.04
21043-XX	0.115	0.141	0.163	0.183	0.200	0.216	0.231	21130-XX	1.06	1.30	1.50	1.68	1.84	1.99	2.12
21500-V025	0.127	0.156	0.180	0.201	0.220	0.238	0.254	21136-XX	1.19	1.46	1.68	1.88	2.06	2.23	2.38
21046-XX	0.133	0.163	0.188	0.210	0.230	0.248	0.266	21140-XX	1.26	1.55	1.79	2.00	2.19	2.37	2.53
21047-XX	0.139	0.170	0.196	0.219	0.240	0.259	0.277	21144-XX	1.31	1.61	1.85	2.07	2.27	2.45	2.62
21049-XX	0.150	0.184	0.212	0.237	0.260	0.281	0.300	21147-XX	1.35	1.65	1.90	2.13	2.33	2.52	2.69
21500-V03	0.150	0.184	0.212	0.237	0.260	0.281	0.300	21150-XX	1.44	1.77	2.04	2.28	2.50	2.70	2.89
21051-XX	0.162	0.198	0.229	0.256	0.280	0.302	0.323	21152-XX	1.49	1.82	2.11	2.36	2.58	2.79	2.98
21052-XX	0.167	0.205	0.237	0.265	0.290	0.313	0.335	21156-XX	1.55	1.90	2.20	2.46	2.69	2.91	3.11
21055-XX	0.191	0.233	0.269	0.301	0.330	0.356	0.381	21161-XX	1.63	2.00	2.31	2.58	2.83	3.06	3.27
21500-V04	0.202	0.247	0.286	0.320	0.350	0.378	0.404	21166-XX	1.71	2.10	2.42	2.71	2.97	3.21	3.43
21060-XX	0.225	0.276	0.318	0.356	0.390	0.421	0.450	21172-XX	1.88	2.31	2.66	2.98	3.26	3.52	3.76
21061-XX	0.231	0.283	0.327	0.365	0.400	0.432	0.462	21177-XX	2.00	2.45	2.83	3.16	3.46	3.74	4.00
21063-XX	0.248	0.304	0.351	0.393	0.430	0.464	0.497	21182-XX	2.08	2.55	2.95	3.30	3.61	3.90	4.17
21500-V05	0.254	0.311	0.359	0.402	0.440	0.475	0.508	21187-XX	2.21	2.70	3.12	3.49	3.82	4.13	4.41
21064-XX	0.254	0.311	0.359	0.402	0.440	0.475	0.508	21196-XX	2.45	3.00	3.46	3.87	4.24	4.58	4.90
21065-XX	0.260	0.318	0.367	0.411	0.450	0.486	0.520	21205-XX	2.65	3.25	3.75	4.19	4.59	4.96	5.30
21067-XX	0.277	0.339	0.392	0.438	0.480	0.518	0.554	21213-XX	2.85	3.49	4.03	4.51	4.94	5.34	5.70
21500-V06	0.300	0.368	0.425	0.475	0.520	0.562	0.600	21218-XX	2.98	3.65	4.21	4.71	5.16	5.57	5.96
21070-XX	0.306	0.375	0.433	0.484	0.530	0.572	0.612	21234-XX	3.47	4.25	4.91	5.49	6.01	6.49	6.94
21073-XX	0.329	0.403	0.465	0.520	0.570	0.616	0.658	21250-XX	4.00	4.90	5.66	6.33	6.93	7.49	8.00

Replacement Parts for ORS & Flow Indicator Fittings

Replacement components for ORS Fittings/Kits

Product	Type/Material	Part#
Ball Retainer	Polypro	20460-02
U-clip	302 SS	20460-02
Flow Indicator Kit w/o Indicator Body	Manifold Feed	20460-11
	Isolated Feed	20480-02
O-rings for ORS fittings	FKM	20460-03
	VITON	20460-15
O-rings for metering orifices	FKM	40225-04
	VITON	40225-05

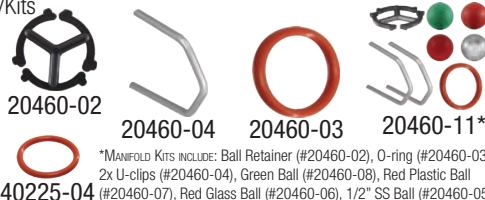

Mounting Clamps for ORS

Two hole mounting clamps with 1/4" bolt-mount for ORS manifolds and flow indicators

Tube Size	Type	Part#
1" Sq Tube	302 SS	40550-SS
1-1/4" Sq Tube	302 SS	40551-SS
1-1/2" Sq Tube	302 SS	40552-SS



Wilger Visual Ball Flow Indicators

The Flow Indicator Advantage See Any Application Accurately



Fittings Swivel
360°



Clear Sight Column



Superior Chemical Resistance



Simple, without Electronics



No Threads or Sealant Required

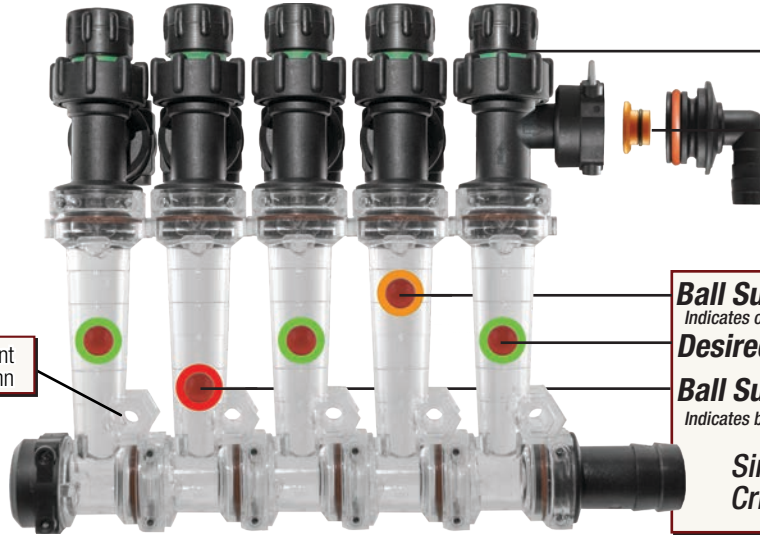

1/4" Bolt mount on each column

Manual ON/OFF Check Valves
Easy to turn off for maintenance or convert equipment to mid-row banding
Larger Metering Orifices
Easier handling & cleaning
Consistent Metering & Easy Cleaning

Ball Suspended Higher
Indicates over flow or leak
Desired Flow

Ball Suspended Lower
Indicates blockage or plug

Simple Operation. Critical Feedback.

Example Flow Indication
Overlay Colors for visual purposes only

Flow Indicators are used on Planting Equipment & Sprayers to indicate relative flow blockage or overage.

Manifold Feed - Ball Flow Indicators

For monitoring many lines from a single feed (e.g. Liquid Fertilizer kits for a planter)

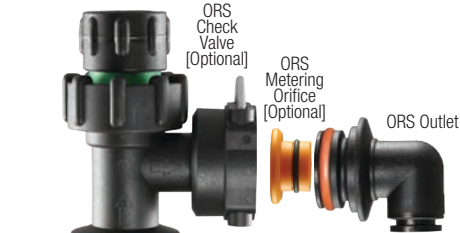

Model	Kit Type*	Part#
Ultra Low Flow [0.01-0.24 us gpm]	Bulk Kit	20475-BULK
	Bagged Kit	20475-00
	Body Only	20475-01
Low Flow [0.05-0.65 us gpm]	Bulk Kit	20470-BULK
	Bagged Kit	20470-00
	Body Only	20470-01
Standard Flow [0.07-2.70 us gpm]	Bulk Kit	20460-BULK
	Bagged Kit	20460-00
	Body Only	20460-01

*MANIFOLD KITS INCLUDE: Indicator Body, Ball Retainer (#20460-02), O-ring (#20460-03), 2x U-clips (#20460-04), Green Ball (#20460-08), Red Plastic Ball (#20460-07), Red Glass Ball (#20460-06), 1/2" SS Ball (#20460-05)

Ball Retainer
Sight Column
Red Glass Ball
1/4" Bolt-Mount Hole
Stackable ORS-F port for inlet

Stackable ORS-M port can be capped off

Flow Indicator & ORS Specifications*

Max Operating Pressure: 100PSI / 7BAR
Max Metered Flow Rate: Up to 8.0 us gpm
Max Operating Pressure: 185°F / 85°C
O-ring Seals: FKM (standard) / Viton
U-clip/Metal Fittings: Stainless Steel (302)
ORS Fittings: Glass-reinforced Polypropylene
Flow Columns: TPX™ (Polymethylpentene)

Isolated Feed - Ball Flow Indicators

For monitoring single lines from individual feeds (e.g. Squeeze pump monitoring, chemical injector pumps)



Model	Kit Type**	Part#
Low Flow [0.05-0.65 us gpm]	Bulk Kit	20490-BULK
	Bagged Kit	20490-00
	Body Only	20490-01
Standard Flow [0.07-2.70 us gpm]	Bulk Kit	20480-BULK
	Bagged Kit	20480-00
	Body Only	20480-01

**ISOLATED KITS INCLUDE: Flow Indicator Body, Ball Retainer (#20460-02), U-clip (#20460-04), Green Ball (#20460-08), Red Plastic Ball (#20460-07), Red Glass Ball (#20460-06), 1/2" Stainless Ball (#20460-05)

Inlet feed uses Combo-Jet cap. Refer to COMBO-JET caps & adapters.

How to Tell Columns Apart? Check the top of the column.

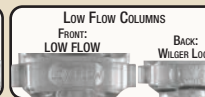
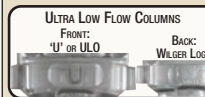

Required Storage for Flow Indicator Columns

Wilger Flow Indicator columns are made of a specialty UV-stabilized compound (TPX™) that maximizes chemical resistance, providing compatibility for a huge range of chemical applications.

As with any plastic, UV exposure degrades the flow indicator columns.

To maximize flow indicator column clarity & longevity, completely cover the flow indicator columns from UV exposure (sun/etc.) when not in use.

PRO TIP: Using two balls simultaneously helps adapt to cover changes in rate & speed

If a lighter ball suspends too high, using the next heavier ball below can cover changes in application rates or speeds.









Red Celcon Ball Lower Rate/Speed
Red Glass Ball Higher Rate/Speed



Wilger Visual Ball Flow Indicators - Balls & Setup Guide

Flow Indicator Balls & Selection Chart

Weighted balls are used inside flow indicator columns and within the operational flow range, will suspend within the column, showing relative flow rate to other flow columns.

Ball Description & Color	Part #	Flow Indicator Columns & Flow Ranges*		
		Ultra Low Flow	Low Flow	Standard Flow
 Orange Polypropylene Ball*	20460-13	0.01-0.04 us gpm	0.05-0.12 us gpm	0.07-0.25 us gpm
 Green Polypropylene Ball*	20460-08	0.01-0.04 us gpm	0.05-0.12 us gpm	0.07-0.25 us gpm
 Red Celcon Ball*	20460-07	0.02-0.06 us gpm	0.06-0.16 us gpm	0.10-0.35 us gpm
 White Celcon Ball*	20460-18	0.02-0.06 us gpm	0.06-0.16 us gpm	0.10-0.35 us gpm
 Pink Celcon Ball*	20460-14	0.02-0.06 us gpm	0.06-0.16 us gpm	0.10-0.35 us gpm
 Red Glass Ball	20460-06	0.06-0.13 us gpm	0.12-0.26 us gpm	0.21-0.72 us gpm
 1/2" Stainless Steel (302) Ball	20460-05	0.13-0.24 us gpm	0.18-0.65 us gpm	0.40-1.70 us gpm
 7/16" Stainless Steel (302) Ball	20460-10	n/a	n/a	1.00-2.70 us gpm

*Density/Viscosity of liquid used can effect operating range. In very dense liquids, balls may float.

Applying Dark Fertilizers & Variable Rate Applications

With more liquid fertilizers and products being darker (e.g. humic acid content), consider a few tips that may help visual representation of flow.

For Red Liquids
(e.g. Paralign Fertilizer)
White backboard for improved visibility.
White celcon ball for red liquids.



For Dark Liquids
(e.g. Humic Acid)
Pink celcon ball for black & dark liquids.



For Variable Rate
Considering using two balls to better illustrate changes in flow rate. Select a lighter ball for the lower rate, and heavier for the higher rate.



Ball Selection Example

Liquid Weight: 10.67 lbs/ US Gallon
Speed: 5 mph
Outlet Spacing: 30 inch



Ultra-Low Flow
Rate: 4.5 US Gal/Acre
Flow Rate: 0.129 us gpm
Ball: Red Glass



Low Flow
Rate: 10 US Gal/Acre
Flow Rate: 0.286 us gpm
Ball: 1/2" Stainless



Standard Flow
Rate: 20 US Gal/Acre
Flow Rate: 0.571 us gpm
Ball: Red Glass

Guide to Building a Liquid Kit with Flow Indicator Manifolds

STEP 1 Select: Manifold-Feed or Isolated-Feed Style Flow Columns

Choose the style of flow column that suits the application equipment being monitored

STEP 2 Determine Flow Indicator Column Size (e.g. Ultra Low Flow, Low Flow, Standard Flow)

Depending on the flow rates required, select the flow column that would provide the best fit to the required flow rate or range. Usually this is accomplished by finding a column size that has your flow rate towards the middle of the range or higher.

STEP 3 Select: Flow Indicator Balls to use

Consult the ball flow chart to determine which balls should be used. It can be optional to use two balls to illustrate a flow rate range.

STEP 4 ORS Check Valves [Optional]

A variety of check valves are available. Typically an ORS to ORS check valve would be used unless adapting a manifold to combo-jet caps. One check valve is required per flow indicator.

STEP 5 ORS Inlet Feeds, Tees, & Strainers

Determine how many manifolds are required, whether the manifolds are fed with a Tee fitting, as well as whether an inline strainer will be added to each manifold. Determine the size & type of inlet fitting. One set of inlet/tee/strainer is required per manifold.

STEP 6 ORS Metering Orifices [Optional]

Any metering manifold should have a means to meter the flow for each row to keep rows consistent. Without a metering orifice, the flow rates between rows can vary greatly. One metering orifice would be required per flow indicator column.

STEP 7 ORS Outlet

Select the size, and style of outlet to be used for each row of product. Consider applying a small bit of lubricant (e.g. liquid silicone) on the o-ring to air in easy installation of outlets and other ORS fittings. The outlet would hold the ORS metering orifice, if used.

STEP 8 ORS End Caps & Adapters

A variety of end caps are available as adapters which can be used for many situations, but typical an ORS end cap would be used. Two end caps are required per manifold if a Tee fitting is used.

Do you plant at night or in low visibility? Take a look at Wilger's Electronic Flow Monitoring (EFM) System

Wilger's row-by-row flowmeter uses the same ORS parts and manifolds, and can be simply added inline for existing manifolds.

Simply add a flowmeter for each row and connect the electronic harness to see actual flow rate on each row (up to 200 rows), for flow rates of 0.04-1.53 us gpm flow.

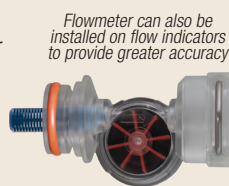

Flowmeter can also be installed on flow indicators to provide greater accuracy

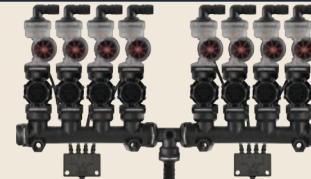

Wilger Electronic Flow Monitoring System

The Electronic Flow Monitoring Advantage

See Any Application with Row-by-Row Accuracy

The Wilger electronic flowmeter (EFM) is a service-able flowmeter designed & built specifically for agricultural chemical & liquid applications.



Fittings Swivel 360°



Crystal Clear Flowmeter



Superior Chemical Resistance



Serviceable Flowmeter for Ag.



High Accuracy Flowmeter



Patented Flowmeter
Canadian Patent No. 2987646
AUS Patent No. 2017376849
U.S. Patent No.10,845,228

Crystal Clear Flowmeters
Enables easy system troubleshooting & verification

Monitors Huge Flow Range
Accurately measures flow rates of 0.04-1.53 us gpm per row

How It Works
High Resolution Hall-Effect Sensor & Ceramic Magnet combo provide accurate pulse frequency to determine flow

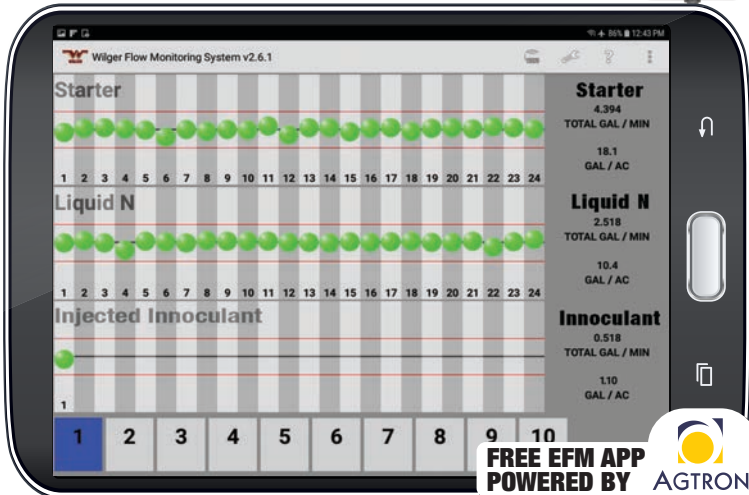
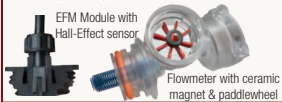

The Electronic Flow Monitoring system (powered by Agtron) requires an Android Tablet 8.0 or later.

Trouble-free Connectors
Keyed Deutsch connectors ensure weather-sealed wiring

Monitor up to 3 Products
Simultaneously monitor up to 3 products within the same system

Monitor Any Sized Equip.
Monitor up to 200 rows or outlets on any equipment

Custom High/Low Alarms
Customize threshold alarms

Custom Screen Layouts
Customize screen layouts between products, sections, or any other way

Chemical Resistance
Clear TPX material provides visual & non-stick surface

Easy Retrofit
Easily retrofits to any existing ORS or Flow Indicator Fittings

Simple Harnessing
Composed of an ECU with dairy-chained product nodes & sensors

WiFi communication
ECU generates WiFi straight into the cab

FREE EFM APP POWERED BY **AGTRON**

Build your Electronic Flow Monitoring System with help from www.wilger.net



Use the new EFM system parts kit builder available at www.wilger.net.
Simply input your implement size and layout and receive a parts list & quote. Simple as that.

Compact ECU for Demo Units & Planters up 16 Rows

NEW



Wilger is introducing a compact flow monitoring system ECU, that acts as a standard ECU with built-in 16 channel node.

For an even easier setup for in-store demonstration or as fully functional 16-row planter EFM systems.

Available now in limited quantities.
Book yours today!

Wilger Electronic Flow Monitoring System Components

Electronic Flowmeters & Jets

A clear flowmeter that connects to any ORS outlets, with an accurate flow range of 0.04 - 1.53 us gpm, using patented flow stabilizing jets.

20580-00 EFM KIT
Includes 4 Sizes of EFM jet

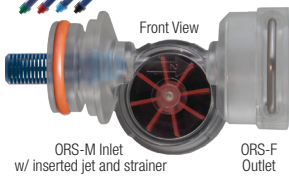

20580-06 Body Assembly
EFM BODY ASSY
[no jets, wire side showing]



Product	Description	Part#
Electronic Flowmeter Body [0.04-1.53 us gpm]	Flowmeter Kit	20580-0
	Body Assembly (no jets)	20580-06
	Body Only	20580-01
Replacement Jets (with 50 mesh snap-in strainer)	Green (up to 0.12 us gpm)	20581-01
	Red (0.1 - 0.31 us gpm)	20581-03
	Blue (0.18 to 0.98 us gpm)	20581-05
	Black (0.6 to 1.53 us gpm)	20581-07



*Jets include snap-in strainers for easy handling

Electronic Flowmeter Manifolds

Pre-assembled manifolds in 1-4 Outlets with a flowmeter and check valve. Simply stack manifolds, then add inlet/outlets, caps and sensor cables.

20644-00 Four Outlet EFM Manifold Kit w/ Check Valve
Kit includes 20574-00, 4x 20580-00, 4x 20556-00

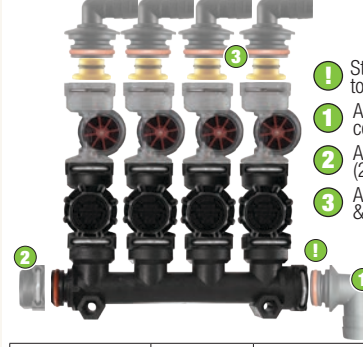

- Stack manifold sections to desired size.
- Add ORS inlet or center-fed tee
- Add ORS outlets & metering orifice (opt.)

[Included]
20581-XX
EFM Jet set
[1 set per EFM]



Manifold Outlets	Check Valve*	Part#
1 EFM Outlet	Straight	20641-00
	90°	20631-00
2 EFM Outlet	Straight	20642-00
	90°	20632-00
3 EFM Outlet	Straight	20643-00
	90°	20633-00
4 EFM Outlet	Straight	20644-00
	90°	20634-00

*4PSI check valves available: change '-00' to '-P4'. For ultra-low flow (<0.01 us gpm), 4PSI may be required.

Required Storage for Flowmeters

Wilger Flowmeters are made of a specialty UV-stabilized compound (TPX™) that maximizes chemical resistance, providing compatibility for a huge range of chemical applications. As with any plastic, UV exposure degrades the flow indicator columns.

To maximize flowmeter clarity & longevity, completely cover the flowmeters from UV exposure (sun/etc.) whenever possible.

Base Electronic Kits for EFM Systems

Electronic Control Units (ECU) and other components that are used for all product node types. ECUs are used to monitor up to 196 outlets, across up to 3 products.

Product	Kit Includes	Part#
ECU Base Kit	ECU, 20' 12v Harness, Terminator, Antenna	20603-00
ECU Splitter Kit	ECU Splitter Cable, Terminator	20605-00
Compact ECU Kit	Compact ECU, node harness, CAN power	20603-00
ECU/Node to Node Extension Harness	12' Extension Harness (Node to ECU/Node)	20616-12
	24' Extension Harness (Node to ECU/Node)	20616-24

20603-00 ECU Base Kit, Breakdown

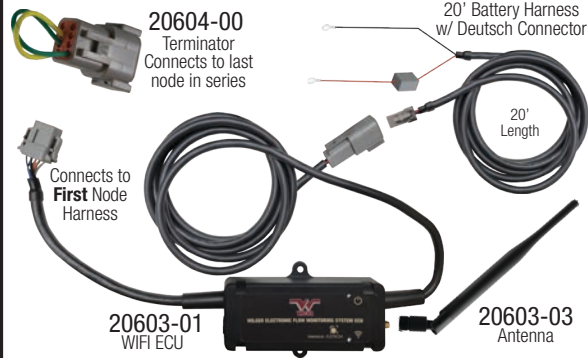

20605-00 ECU Splitter Kit

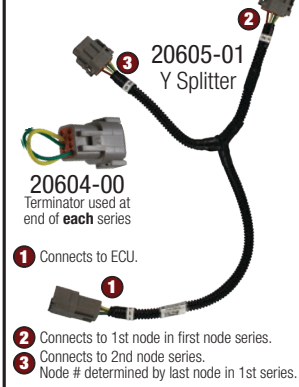

20625-00 Compact ECU Kit for Demo units & up to 16 row planters

Compact ECU can be wired to Tablet, or WIFI



16 Channel (16CH) Product Node Kits & Components

16CH Product nodes provide communication between sensors and ECU.

Product	Description	Part#
16CH Node Kit	incl. 16CH Node, 16CH Harness, 4x Quad-sensor cables	20621-00
Quad-Sensor Cable	4-Sensor Cable (18" long) for 16CH Node	20585-00
16CH Node/Harness	incl. 16CH Product Node, 16CH Node Harness	20611-00
16CH Harness Cap	16CH Harness Cover Cap	20612-00
Sensor Cover Cap	Covers a single sensor on a quad-sensor cable	20585-01
Node to Quad-Sensor Extensions	6' Extension Cable (16CH Harness to quad-sensor cable)	20615-06
	12' Extension Cable (16CH Harness to quad-sensor cable)	20615-12

20621-00 16 CHANNEL (16CH) NODE KIT BREAKDOWN

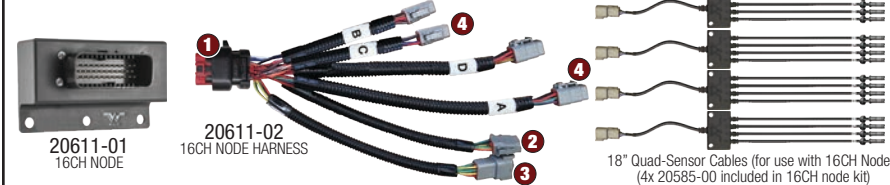

- Node Connects to Harness
- Connects to next node in series
- Connects to ECU (or previous node)
- Connects to (4) quad-sensor cables

Capping Unused Connections & Sensors

For proper function of your EFM system, each unused connection must be sealed with a node harness cover cap, sensor cap, or terminator. Unsealed Connections have increased chance of shorts, electrical shock, or damage to the system or equipment.

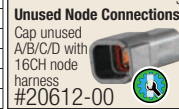

Wilger Electronic Flow Monitoring System Components

Limited Stock

4 Channel (4CH) Product Node Kits & Components

4 Channel Product Nodes & kits provide communication between sensors and ECU. Sensor cables cannot be interchanged between 16CH and 4CH node harnesses. 4CH nodes and sensors are available in limited stock, as Wilger is transitioning to using the 16CH node and components as standard.

Product	Description	Part#
4CH Node Kit	incl. 4CH Node, 4CH Harness, 4x 6" single-sensor cables	20620-00
4CH Node/Harness	incl. 4CH Product Node, 4CH Node Harness	20608-00
4CH Harness Cap	4CH Harness Cover Cap	20609-00
Single-Sensor Cables (lim. qty)	6" single-sensor Cable for 4CH Node harness	20584-00
	10' single-sensor Cable for 4CH Node harness	20584-10

Capping Unused Connections

For proper function of your EFM system, each unused connection must be sealed with a 4CH node harness/sensor cover cap, or terminator.

Unused Sensor Connections

Cap unused 4CH node harness connections
#20609-00



Terminators

Cap all 'last node in series' connections
#20604-00



20620-00 4 CHANNEL (4CH) NODE KIT BREAKDOWN

Single Sensor Cables (for 16CH Nodes)

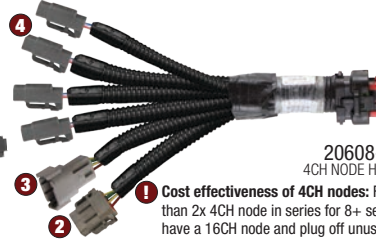
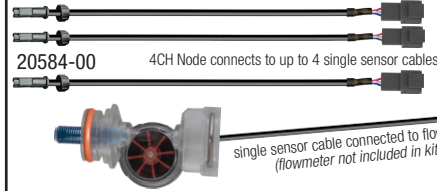

- 1 Node Connects to Harness
- 2 Connects to next node in series
- 3 Connects to ECU (or previous node)
- 4 Connects up to 4 single sensor cables

1 Cost effectiveness of 4CH nodes: For any configurations requiring more than 2x 4CH node in series for 8+ sensors, it can be more cost effective to have a 16CH node and plug off unused harness connectors.

Electronic Flow Monitoring System: Auxiliary Component Parts

Electronic flow monitoring system parts and components are easily replaceable. For individual component parts that were not listed in the above product breakdowns, find the below.

- 20580-06 EFM, Body Assy, TPX, ORS (no jets, body assy only)
- 20580-01 EFM, Body Only, TPX
- 20580-02 EFM, Module c/w O-ring (no sensor)
- 20580-08 EFM, Impeller Assembly (20580-08 + 20580-10)
- 20580-10 EFM, Impeller Magnet, Ceramic
- 20580-11 EFM, Impeller Axle Pin
- 20580-13 EFM, O-Ring, #119, VITON® (for EFM module)
- 20583-00 EFM Sensor Cable, Single w/o Connector
- 20585-01 EFM sensor rubber cover (for unused sensor cables)



EFM Retrofit Options

The EFM can easily retrofit into existing flow indicator manifolds.

The upgrade gives visual & electronic feedback for the next step of accuracy!

More info @ www.WILGER.NET

Example of an 16-row Planter, applying liquid fertilizer

Expand system to larger planters or implements by simply adding 16CH nodes in series

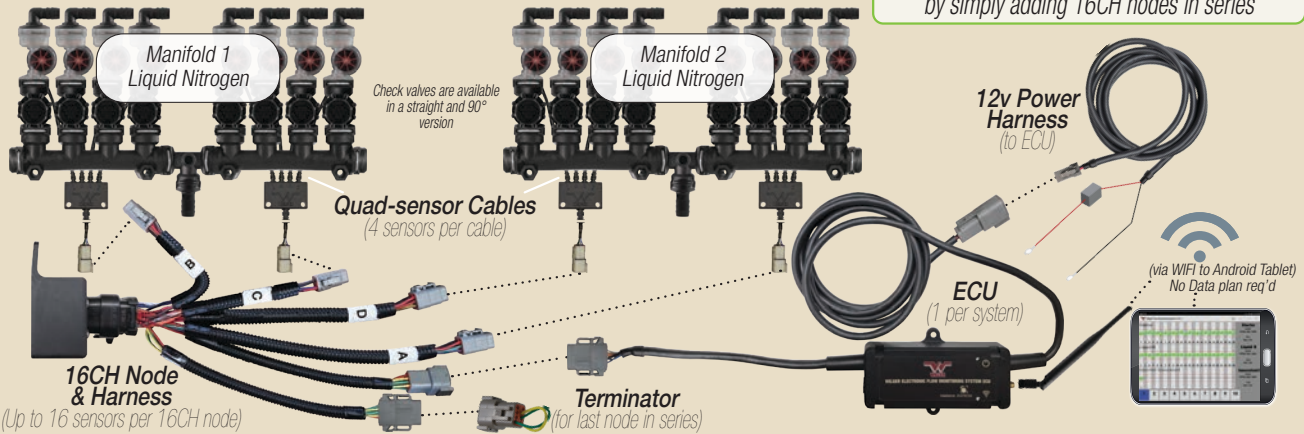

Component Checklist for Wilger's Electronic Flow Monitoring System

As equipment & implements vary greatly, this is a simplified approach assuming the implement is fairly standard and evenly spread, with the manifold centrally located. In many cases, it is more cost effective to move manifolds, from the wings of the implement, to the center.

- 1 Order 1 ECU assembly per system. (#20603-00)
- 2 Add the # of outlets (including multiples for monitoring multiple products). Divide the total # of outlets by 16. Round up to nearest whole number. Order that many 16CH Node kits. (#20621-00)
4CH Node kits can also be effective for 'extra' outlets in systems as needed, but 16CH node kits are typically more cost effective.
- 3 Order 1 EFM assembly kit (#20580-00) per outlet (incl. multiples for monitoring multiple products)
Alternatively, order EFM manifold kits (#20631-00 to #20634-00) to fit your requirements for sections.
- 4 Order 1 ORS Outlet (Page 16) & 1 ORS Check Valve (#20551-00) per EFM body.
Order manifolds & plumbing components (& end caps) suited for the implement size.
- 5 [Optional if metering orifice req'd] Order orifice (Page 17) for each outlet, ensure proper metering orifice size for each product/rate. Use Tip Wizard online @ www.wilger.net or the free app, to ensure proper sizing.

For more information, start the conversation on building your EFM system with your Wilger dealer, and for more pictures/information, visit our website at: www.WILGER.NET

EFM System Checklist

- 1x ECU KIT per system
- 1x 16CH Node Kit per 16 outlets
- 1x Flowmeter (EFM) per outlet
- 1x ORS Manifold Outlet per outlet
- 1x ORS Check Valve per outlet
- 1x Inlet Feed or Tee per manifold
- 1x End Cap per manifold [2x if Tee'd]
- Extension harnesses if req'd
- 1x Android 8.0 Tablet or newer

For a simpler start to customizing an EFM system, use the new EFM system parts kit builder available at www.wilger.net.

Simply input your implement size and layout and receive a parts list & quote.

Simple as that.



EFM VIDEO TUTORIALS - Setting up EFM App on Android Tablet

Make sure to take advantage of video tutorials on initial setup and planning of EFM system app on your Android Tablet. Videos on YOUTUBE, or accessible from www.WILGER.NET



Case IH Sprayer with AimCommand Flex
(www.caseih.com)
USA

Wilger makes spray tips for applicators who care about how they spray.



Smithco Sprayer with PinPoint II
(www.smithco.com)
USA



Pattison CONNECT Autonomous OMNI Sprayer with recirculating boom
(www.liquidsystems.net/connect)
Canada

Wilger makes nozzle bodies & components that address and support best practices being developed in the crop protection industry.

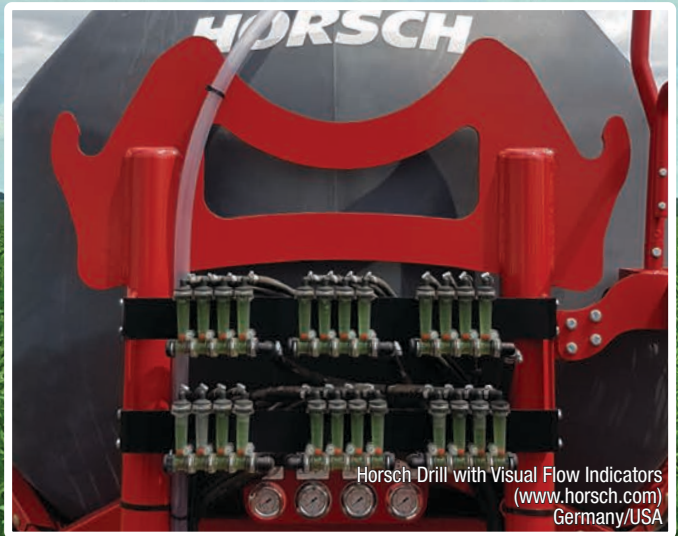

Horsch Drill with Visual Flow Indicators
(www.horsch.com)
Germany/USA



RECORD Flow Monitoring System partnered with LLC TRACK
(www.seeding.com.ua)
Ukraine

Wilger makes flow monitoring & metering components that are critical to maintaining effective and consistent application.

 **CANADA**
Wilger Industries Ltd.
Site 412, Box 280, RR#4
Capital Circle W & Auction Mart Rd.
Saskatoon, SK, Canada S7K 3J7
Phone: 1 (833) 242-4121
Fax: (306) 242-4122
Email: info@wilger.net

 @WilgerParts

 **UNITED STATES**
Wilger Inc.
255 Seahorse Drive
Lexington, TN, USA
38351-6538
Phone: (877) 968-7695
Fax: (877) 968-7613
Email: WilgerEsc@WilgerEsc.com

 @WilgerInc

 **ARGENTINA**
Wilger Argentina
Mitre 699
San Nicolas (2900)
Buenos Aires, Argentina
Phone: +54 9 336 4596710
Email: cjpurras@gmail.com

**Focused on Application
Performance for
Over 45 Years**

www.wilger.net

All Wilger trademarks and logos are owned by Wilger Industries Ltd. All other brand or product names are trademarks or registered marks of their respective owners. All rights reserved.

Printed in Canada